

EGS



Device systems

Ukraine

2019/2020 edition

Building Connections

OBO
BETTERMANN











**Contact
Customer Service
+38 (044) 494 30 89**

Service times
Monday to Friday 09.00 to 18.00

**info@obo.com.ua
www.obo.ua**



Planning and mounting aids

	Planning and mounting aids	4
	Modul 45® – devices	17
	Modul 45® – device installation solutions for surface and concealed mounting	53
	Modul 45® and standard installation solutions for device installation ducts and service poles with an 80 mm system opening	57
	Modul 45connect® – plug-in installation solutions for device installation ducts and service poles	67
	Modul 45connect® – plug-in installation solutions for raised and cavity floor	81
	Workplace solutions – Deskboxes and Flexkanal	99
	Modul 45® and standard – Suspended power supply units VH / VHF	111
	Directories	125

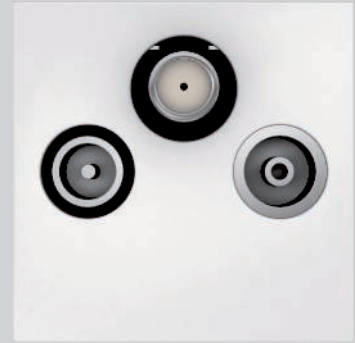

Modul 45® – devices

With their dimensions of 45 x 45 mm, the Modul 45 devices from OBO Bettermann are compact and space-saving. For this reason, the sockets, data and multimedia technology connections are ideal for use in underfloor systems, device installation ducts and service poles. The Modul 45 system makes optimum use of limited installation space.

The advantages of Modul 45 at a glance:

- Space savings thanks to compact design
- Modular structure
- Quick and easy planning
- Easy mounting
- High efficiency due to time and cost savings
- Wide range of application options
- Easy exchangeability



Installation in floor boxes



Installation in device installation ducts



Installation in service poles



Modul 45® devices

Modul 45®
Protective contact and earthing pin sockets



Modul 45®
Country-specific sockets



Modul 45®
Switching and protection devices



Modul 45®
Data technology



Modul 45®
Multimedia technology





Modul 45®

One system – many solutions

The Modul 45 devices from OBO Bettermann offer the right solution for every application – no matter whether you're dealing with sockets, data or multimedia technology.

- Multiple sockets for economic device installation
- Sockets for international applications
- Modul 45connect sockets for quick, secure installation
- Data technology supports for data modules of different manufacturers
- Multimedia connection solutions for data, video and audio transmission



Modul 45[®]

One system
All kinds of applications



Modul 45[®] in the
Rapid 45 device in-
stallation duct



Modul 45[®] in the
Rapid 80 device in-
stallation duct

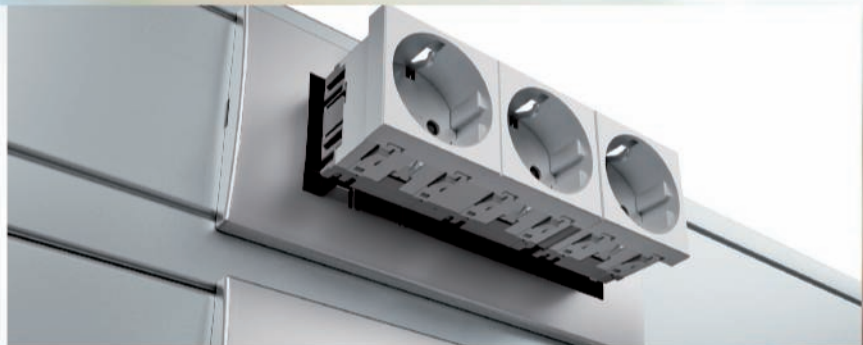

Modul 45[®] in under-
floor service units
and cassettes



Modul 45[®] in under-
floor floor sockets
and floor boxes



Modul 45® in the Modal net surface-mounted housing



Modul 45® in the Modal net cavity wall installations



Modul 45® in suspended power supply units

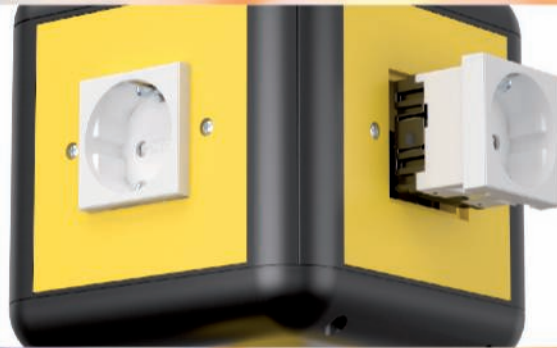

Modul 45® in industrial service poles



Modul 45® in service poles



Push in. Lock. And that's it.
Work faster with Modul 45® devices

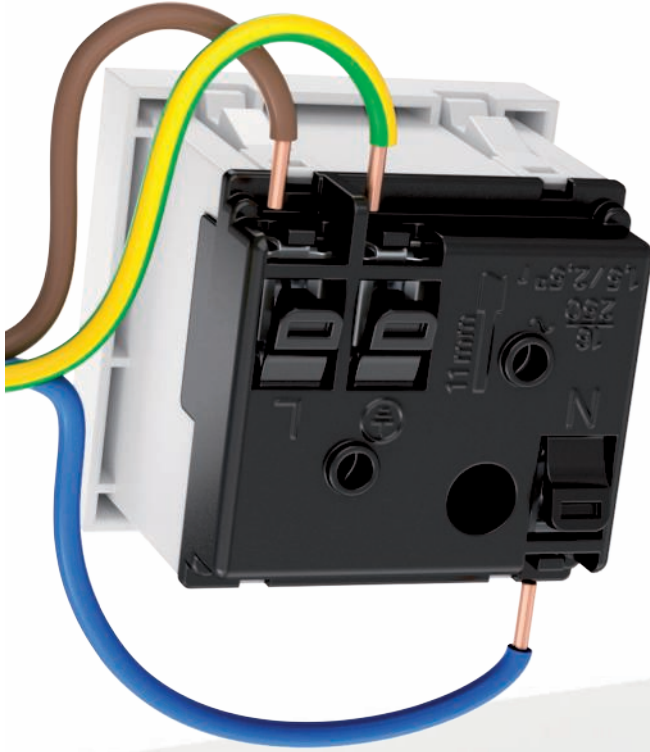

Connection of Modul 45® sockets

The screwless terminals correspond to IEC 60884-1 and are suitable for the connection of rigid cables of 1.5 to 2.5 mm². Each screwless terminal can accept two conductors.

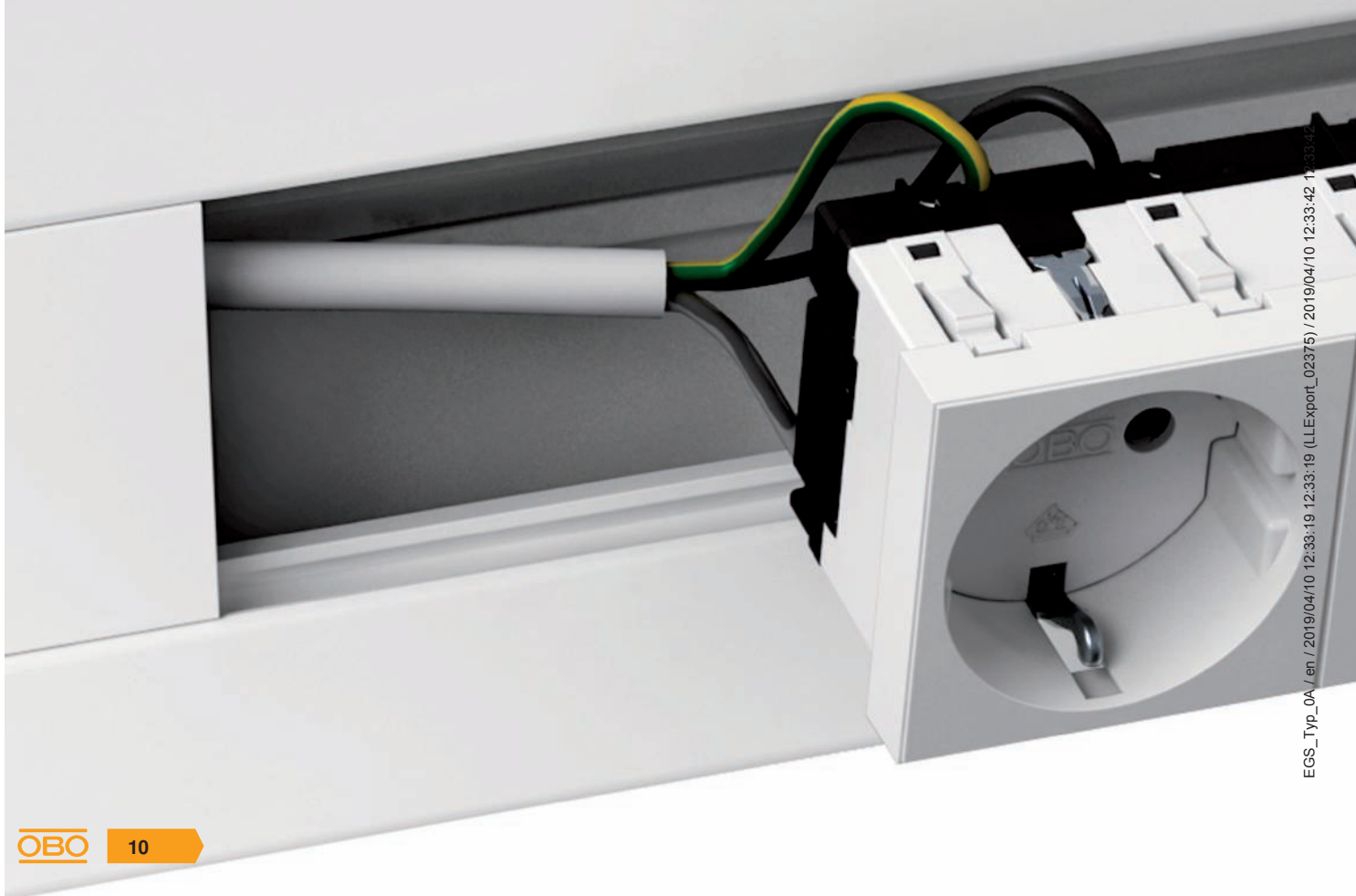



Multiple sockets



The multiple sockets, in the double and triple versions, are particularly economic and time-saving during installation. In a standard installation, the wiring of the individual sockets takes a lot of time. This time is not required at all when installing the multiple sockets.



Time saved

The integrated screwless terminals and the tried-and-trusted locking fastening allow toolless mounting. The wide range of country-specific sockets offers the right solution for any system environment.



Modul 45® data and multimedia technology

Today, we cannot picture offices without a data network. Flexible cabling solutions and data connection modules are used with increasing frequency. OBO can offer various data connection modules, both with and without shielding: Cat. 5e, Cat. 6 and Cat. 6a. The data connection modules are simply snapped into the Modul 45 data technology support.

With the multimedia connection solutions, computer, video and audio connections can be installed in the different OBO system environments. No matter whether in the GES service unit, in cassettes or in System 55 – with the Modul 45 support plate, mounting is easy and quick.



Practical connection solutions

We have the right connection solution for every connection type: Whether you are routing pre-terminated cables or conventional installation cables.

- Solder connection or screw connection for conventional cable connections
- Connection cable or 1:1 coupling to connect pre-terminated cables





Modul 45® data technology support

A large selection of different data technology support is available for the installation of the connection modules. In so doing, data technology supports of other manufacturers can be installed.



Integrated dust protection

Integrated dust protection flaps cover the data connection modules when unused. They protect them against dust and other outside influences. During use of the data socket, the dust protection flaps are pushed upwards. After the connection cables have been removed, the dust protection flaps close again automatically.

Test marks

	STOWARZYSZENIE ELEKTRYKÓW POLSKICH, Poland
	KEMA-KEUR, Netherlands
	Österreichischer Verband für Elektrotechnik, Austria
	Verband der Elektrotechnik, Elektronik, Informationstechnik e.V., Germany

Pictogram explanation



Surfaces

FS	Strip-galvanised
EL	Anodised





Conformity symbol

CE	Communautés Européennes, EC declaration of conformity according to EC directives
-----------	--

Quality marks

	Halogen-free; without chlorine, fluorine and bromine
	UV-RESISTANT

Specific product symbols

	Diameter 60 mm
	Diameter 68 mm
	Protection device to DIN EN 61643-11 or IEC 61643-11
	Transition from LPZ 2 to LPZ 3
	Acoustic signalling

Metals

Alu	Aluminium
VA	Stainless steel, grade 304
St	Steel

Plastics

PA	Polyamide
PC	Polycarbonate
PE	Polyethylene
PP	Polypropylene
PS	Polystyrene
PVC	Polyvinylchloride

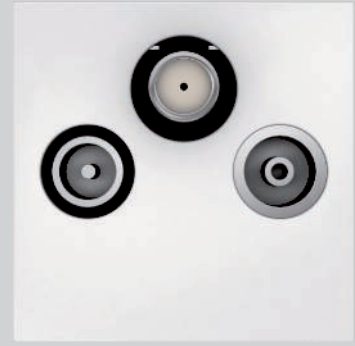

Modul 45® – devices







With their dimensions of 45 x 45 mm, the Modul 45 devices from OBO Bettermann are compact and space-saving. For this reason, the sockets, data and multimedia technology connections are ideal for use in underfloor systems, device installation ducts and service poles. The Modul 45 system makes optimum use of limited installation space.

The advantages of Modul 45 at a glance:

- Space savings thanks to compact design
- Modular structure
- Quick and easy planning
- Easy mounting
- High efficiency due to time and cost savings
- Wide range of application options
- Easy exchangeability



Modul 45® – devices

	Modul 45® – sockets	18
	Modul 45®, USB charging device	26
	Modul 45®, surge protection for sockets	27
	Modul 45®, switching devices	39
	Modul 45®, data technology solutions	42
	Modul 45®, multimedia solutions	44
	Modul 45®, installation components	51

Socket 0°, protective contact, single

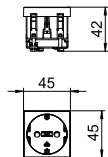

Type	STD-D0 RW1	STD-D0 ROR1	STD-D0 MZGN1	STD-D0 SRO1	STD-D0 SWGR1	STD-D0 AL1
Colour	Pure white	Pure orange	Mint green	Signal red	Black-grey	Aluminium painted
Pack. pcs	1	1	1	1	1	1
Weight kg/100 pcs.	4.200	4.200	4.200	4.200	4.200	4.200
Item No.	6120008	6120010	6120012	6120014	6120016	6120018

PC Polycarbonate

Protective contact socket single 0°, with increased touch protection, with screwless terminals, 2-pin, 16 A, 250 V~, with connection terminals to IEC 60884-1.

Socket 0°, protective contact, double

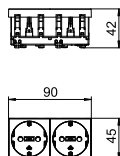

Type	STD-D0 RW2	STD-D0 ROR2	STD-D0 MZGN2	STD-D0 SRO2	STD-D0 SWGR2	STD-D0 AL2
Colour	Pure white	Pure orange	Mint green	Signal red	Black-grey	Aluminium painted
Pack. pcs	1	1	1	1	1	1
Weight kg/100 pcs.	8.000	8.000	8.000	8.000	8.000	8.000
Item No.	6120022	6120024	6120026	6120028	6120030	6120032

PC Polycarbonate

Protective contact socket double 0°, with increased touch protection, with screwless terminals, 2-pin, 16 A, 250 V~, with connection terminals to IEC 60884-1.

Socket 0°, protective contact, triple

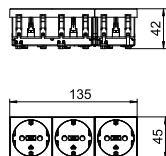

Type	STD-D0 RW3	STD-D0 ROR3	STD-D0 MZGN3	STD-D0 SRO3	STD-D0 SWGR3	STD-D0 AL3
Colour	Pure white	Pure orange	Mint green	Signal red	Black-grey	Aluminium painted
Pack. pcs	1	1	1	1	1	1
Weight kg/100 pcs.	12.200	12.200	12.200	12.200	12.200	12.200
Item No.	6120042	6120044	6120046	6120048	6120050	6120052

PC Polycarbonate

Protective contact socket triple 0°, with increased touch protection, with screwless terminals, 2-pin, 16 A, 250 V~, with connection terminals to IEC 60884-1.

Encoding pin

Type	Colour	Pack. pcs	Weight kg/100 pcs.	Item No.
CST-STD K	Black-grey	10	0.200	6120797

PC Polycarbonate

Encoding pin as socket attachment for the use of encoded sockets, type STD.

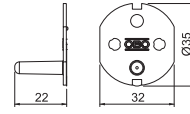

Socket 33°, protective contact, single

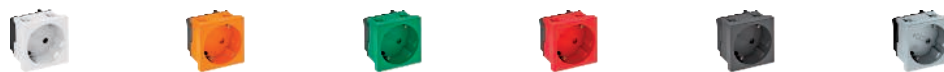
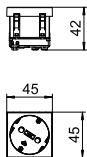

Type	STD-D3 RW1	STD-D3 ROR1	STD-D3 MZGN1	STD-D3 SRO1	STD-D3 SWGR1	STD-D3 AL1
Colour	Pure white	Pure orange	Mint green	Signal red	Black-grey	Aluminium painted
Pack. pcs	1	1	1	1	1	1
Weight kg/100 pcs.	4.000	4.000	4.000	4.000	4.000	4.000
Item No.	6120072	6120074	6120076	6120078	6120080	6120082

PC Polycarbonate

Protective contact socket single 33°, with increased touch protection, with screwless terminals, 2-pin, 16 A, 250 V~, with connection terminals to IEC 60884-1.

Socket 33°, protective contact, double

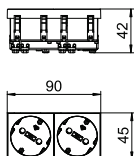

Type	STD-D3 RW2	STD-D3 ROR2	STD-D3 MZGN2	STD-D3 SRO2	STD-D3 SWGR2	STD-D3 AL2
Colour	Pure white	Pure orange	Mint green	Signal red	Black-grey	Aluminium painted
Pack. pcs	1	1	1	1	1	1
Weight kg/100 pcs.	7.800	7.800	7.800	7.800	7.800	7.800
Item No.	6120102	6120104	6120106	6120108	6120110	6120112

PC Polycarbonate

Protective contact socket double 33°, with increased touch protection, with screwless terminals, 2-pin, 16 A, 250 V~, with connection terminals to IEC 60884-1.

Socket 33°, protective contact, triple

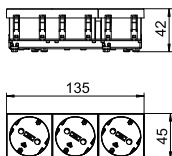

Type	STD-D3 RW3	STD-D3 ROR3	STD-D3 MZGN3	STD-D3 SRO3	STD-D3 SWGR3	STD-D3 AL3
Colour	Pure white	Pure orange	Mint green	Signal red	Black-grey	Aluminium painted
Pack. pcs	1	1	1	1	1	1
Weight kg/100 pcs.	11.000	11.000	11.000	11.000	11.000	11.000
Item No.	6120122	6120124	6120126	6120128	6120130	6120132

PC Polycarbonate

Protective contact socket triple 33°, with increased touch protection, with screwless terminals, 2-pin, 16 A, 250 V~, with connection terminals to IEC 60884-1.

Socket 33°, protective contact, encoded version, single

Type	Colour	Pack. pcs	Weight		Item No.
			kg/100	pcs.	
STD-D3K SRO1	Signal red	1	4.000		6120302

PC Polycarbonate

Power socket single 33°, with increased touch protection with screwless terminals, 2-pin, 16 A, 250 V~, with connection terminals to IEC 60884-1.

The socket can only be used in conjunction with an encoding pin, type CST-STD.

Note: The encoding pin is not contained in the scope of supply.

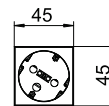
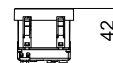

Socket 33°, protective contact, encoded version, double

Type	Colour	Pack. pcs	Weight		Item No.
			kg/100	pcs.	
STD-D3K SRO2	Signal red	1	7.700		6120304

PC Polycarbonate

Power socket double 33°, with increased touch protection with screwless terminals, 2-pin, 16 A, 250 V~, with connection terminals to IEC 60884-1.

The socket can only be used in conjunction with an encoding pin, type CST-STD.

Note: The encoding pin is not contained in the scope of supply.

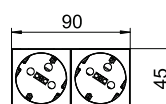
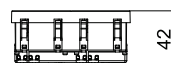

Socket 33°, protective contact, encoded version, triple

Type	Colour	Pack. pcs	Weight		Item No.
			kg/100	pcs.	
STD-D3K SRO3	Signal red	1	11.000		6120306

PC Polycarbonate

Power socket triple 33°, with increased touch protection with screwless terminals, 2-pin, 16 A, 250 V~, with connection terminals to IEC 60884-1.

The socket can only be used in conjunction with an encoding pin, type CST-STD.

Note: The encoding pin is not contained in the scope of supply.

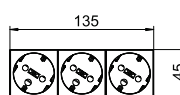

Encoding pin

Type	Colour	Pack. pcs	Weight		Item No.
			kg/100	pcs.	
CST-STD K	Black-grey	10	0.200		6120797

PC Polycarbonate

Encoding pin as socket attachment for the use of encoded sockets, type STD.

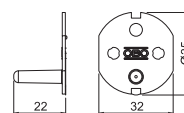

Socket 0°, with earthing pin, single

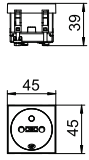

Type	STD-F0 RW1	STD-F0 ROR1	STD-F0 MZGN1	STD-F0 SRO1	STD-F0 SWGR1	STD-F0 AL1
Colour	Pure white	Pure orange	Mint green	Signal red	Black-grey	Aluminium painted
Pack. pcs	1	1	1	1	1	1
Weight kg/100 pcs.	4.000	4.000	4.000	4.000	4.000	4.000
Item No.	6120152	6120154	6120155	6120158	6120160	6120162

PC Polycarbonate

Socket with earthing pin single 0°, with increased touch protection with screwless terminals, 2-pin, 16 A, 250 V ~, with connection terminals to IEC 60884-1.

Socket 0°, with earthing pin, encoded version, single

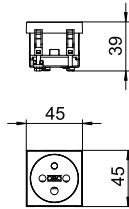

Type	Colour	Pack. pcs	Weight kg/100 pcs.	Item No.
STD-F0K SRO1	Signal red	1	4.000	6120312

PC Polycarbonate

Socket with earthing pin single 0°, encoded version, with increased touch protection, with screwless terminals, 2-pin, 16 A, 250 V~, with connection terminals to IEC 60884-1. The socket can only be used in conjunction with an encoding pin, type CST-STD.

Note: The encoding pin is not contained in the scope of supply.

Encoding pin

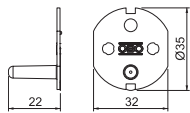

Type	Colour	Pack. pcs	Weight kg/100 pcs.	Item No.
CST-STD K	Black-grey	10	0.200	6120797

PC Polycarbonate

Encoding pin as socket attachment for the use of encoded sockets, type STD.



Socket 33°, with earthing pin, single

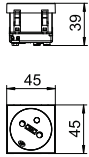

Type	STD-F3 RW1	STD-F3 ROR1	STD-F3 MZGN1	STD-F3 SRO1	STD-F3 SWGR1	STD-F3 AL1
Colour	Pure white	Pure orange	Mint green	Signal red	Black-grey	Aluminium painted
Pack. pcs	1	1	1	1	1	1
Weight kg/100 pcs.	3.800	3.800	3.800	3.800	3.800	3.800
Item No.	6120222	6120224	6120226	6120228	6120230	6120232

PC Polycarbonate

Socket with earthing pin single 33°, with increased touch protection with screwless terminals, 2-pin, 16 A, 250 V ~, with connection terminals to IEC 60884-1.

Socket 33°, with earthing pin, double

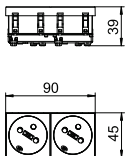

Type	STD-F3 RW2	STD-F3 ROR2	STD-F3 MZGN2	STD-F3 SRO2	STD-F3 SWGR2	STD-F3 AL2
Colour	Pure white	Pure orange	Mint green	Signal red	Black-grey	Aluminium painted
Pack. pcs	1	1	1	1	1	1
Weight kg/100 pcs.	7.500	7.500	7.500	7.500	7.500	7.500
Item No.	6120242	6120244	6120246	6120248	6120250	6120252

PC Polycarbonate

Socket with earthing pin double 33°, with increased touch protection with screwless terminals, 2-pin, 16 A, 250 V ~, with connection terminals to IEC 60884-1.

Socket 33°, with earthing pin, triple

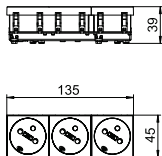

Type	STD-F3 RW3	STD-F3 ROR3	STD-F3 MZGN3	STD-F3 SRO3	STD-F3 SWGR3	STD-F3 AL3
Colour	Pure white	Pure orange	Mint green	Signal red	Black-grey	Aluminium painted
Pack. pcs	1	1	1	1	1	1
Weight kg/100 pcs.	10.500	10.500	10.500	10.500	10.500	10.500
Item No.	6120262	6120264	6120266	6120268	6120270	6120272

PC Polycarbonate

Socket with earthing pin triple 33°, with increased touch protection with screwless terminals, 2-pin, 16 A, 250 V ~, with connection terminals to IEC 60884-1.

Socket 33°, with earthing pin, encoded version, single

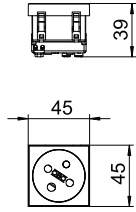

Type	Colour	Pack.	Weight	Item No.
		pcs	kg/100 pcs.	
STD-F3K SRO1	Signal red	1	3.800	6120322

PC Polycarbonate

Socket with earthing pin single 33°, encoded version, with increased touch protection, with screwless terminals, 2-pin, 16 A, 250 V~, with connection terminals to IEC 60884-1. The socket can only be used in conjunction with an encoding pin, type CST-STD.

Note: The encoding pin is not contained in the scope of supply.

Socket 33°, with earthing pin, encoded version, double

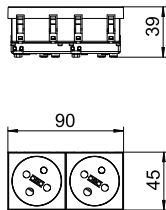

Type	Colour	Pack.	Weight	Item No.
		pcs	kg/100 pcs.	
STD-F3K SRO2	Signal red	1	7.500	6120324

PC Polycarbonate

Socket with earthing pin double 33°, encoded version, with increased touch protection, with screwless terminals, 2-pin, 16 A, 250 V~, with connection terminals to IEC 60884-1. The socket can only be used in conjunction with an encoding pin, type CST-STD.

Note: The encoding pin is not contained in the scope of supply.

Socket 33°, with earthing pin, encoded version, triple

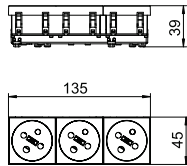

Type	Colour	Pack.	Weight	Item No.
		pcs	kg/100 pcs.	
STD-F3K SRO3	Signal red	1	10.500	6120326

PC Polycarbonate

Socket with earthing pin triple 33°, encoded version, with increased touch protection, with screwless terminals, 2-pin, 16 A, 250 V~, with connection terminals to IEC 60884-1. The socket can only be used in conjunction with an encoding pin, type CST-STD.

Note: The encoding pin is not contained in the scope of supply.

Encoding pin

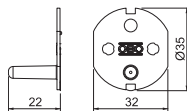

Type	Colour	Pack.	Weight	Item No.
		pcs	kg/100 pcs.	
CST-STD K	Black-grey	10	0.200	6120797

PC Polycarbonate

Encoding pin as socket attachment for the use of encoded sockets, type STD.

Socket 0°, Switzerland, single

Type	Colour	Pack. pcs	Weight kg/100 pcs.	Item No.

PC Polycarbonate

Socket, single 0°, to Swiss standard (SEV), with screwless terminals, 2-pin, 10 A, 250 V~, type 13, with connection terminals to IEC 60884-1.

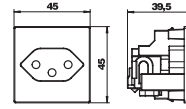

Socket 0°, Italy, single

Type	Colour	Pack. pcs	Weight kg/100 pcs.	Item No.

PC Polycarbonate

Socket, single 0°, Italy P17/11, with increased touch protection, with screw terminals, 2-pin, 16 A, 250 V~.

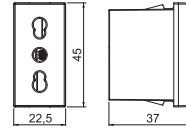

USB charging device

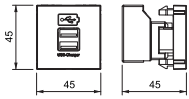

Type	Colour	Pack. pcs	Weight kg/100 pcs.	Item No.
MTG-2UC2.1 RW1	Pure white	1	5.500	6105300
MTG-2UC2.1 SWGR1	Black-grey	1	5.500	6105302
MTG-2UC2.1 AL1	Aluminium painted	1	5.500	6105304

PC Polycarbonate

USB charging device with two USB type A sockets, for charging 1–2 mobile devices, maximum charging current 1 x 2,100 mA or 2 x 1,050 mA.



Fine power protection for Modul 45 with acoustic function display

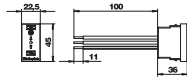

Type ÜSS 45-O-RW

Signalling on device Visual
Version Visual function display

Pack. pcs 1
Weight kg/100 pcs. 2.411

Item No. 6117473

Surge protection / network fine protection, type 3, according to EN 61643-11 for installation in Rapid 45 trunking, device installation trunking and underfloor systems.

- Version-O with acoustic function display
- Quick and easy mounting
- Low construction width of 22.5 mm

Application: The surge protection device secures downstream and nearby sockets.

Fine power protection for Modul 45 with acoustic function display

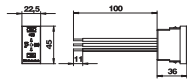

Type ÜSS 45-A-RW

Signalling on device Audible
Version Acoustic function display

Pack. pcs 1
Weight kg/100 pcs. 2.800

Item No. 6117465

Surge protection / network fine protection, type 3, according to EN 61643-11 for installation in Rapid 45 trunking, device installation trunking and underfloor systems.

- Version-A with acoustic function display (switchable signal tone)
- Quick and easy mounting
- Low construction width of 22.5 mm

Application: The surge protection device secures downstream and nearby sockets.



Surge protection module 230 V



Type	Signalling on device	Version	Pack. pcs	Weight kg/100 pcs.	Item No.
ÜSM-A	Audible	Acoustic function display	1	1.500	5092451

Surge protection module type 3 to DIN EN 61643-11 for 230 V power grids.

- With acoustic defect signal
- With low construction height
- Halogen-free plastic (UL 94 V-0)
- Y circuit

Application: Universally applicable for all installation systems.

Dimensions

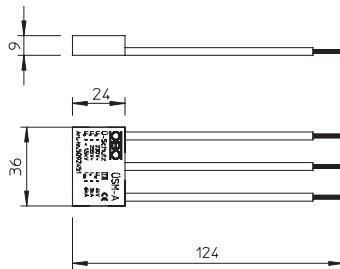

Connection options

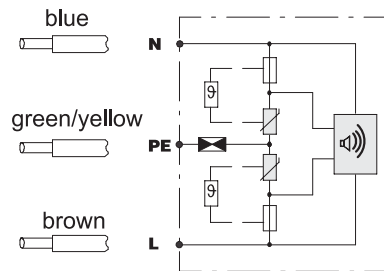

One-way/changeover switch, 1/2 module

Type	Colour	Pack. pcs	Weight kg/100 pcs.	Item No.
WS-UB RW0.5	Pure white	1	1.800	6120920
WS-UB SWGR0.5	Black-grey	1	1.800	6120922
WS-UB AL0.5	Aluminium painted	1	1.800	6120924

PC Polycarbonate

Changeover switch 1-pin, 10 A, 250 V~, with screwless terminals.

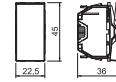

One-way/changeover switch with warning lamp, 1/2 module

Type	Colour	Pack. pcs	Weight kg/100 pcs.	Item No.
WS-UKL RW0.5	Pure white	1	1.800	6120926
WS-UKL SWGR0.5	Black-grey	1	1.800	6120928
WS-UKL AL0.5	Aluminium painted	1	1.800	6120930

PC Polycarbonate

Changeover switch with LED element as control luminaire, 1-pole, 10 A, 250 V~, with screwless terminals.



One-way/changeover switch, 1 module

Type	Colour	Pack. pcs	Weight kg/100 pcs.	Item No.
WS-UB RW1	Pure white	1	2.600	6120932
WS-UB SWGR1	Black-grey	1	2.600	6120934
WS-UB AL1	Aluminium painted	1	2.300	6120936

PC Polycarbonate

Changeover switch 1-pin, 10 A, 250 V~, with screwless terminals.

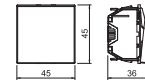

One-way/changeover switch with warning lamp, 1 module

Type	Colour	Pack. pcs	Weight kg/100 pcs.	Item No.
WS-UKL RW1	Pure white	1	2.300	6120938
WS-UKL SWGR1	Black-grey	1	2.300	6120940
WS-UKL AL1	Aluminium painted	1	2.300	6120942

PC Polycarbonate

Changeover switch with LED element as control luminaire, 1-pole, 10 A, 250 V~, with screwless terminals.

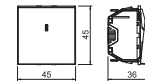

Roller blind switch, 1 module

Type	Colour	Pack. pcs	Weight kg/100 pcs.	Item No.
RS-BS RW1	Pure white	1	3.700	6120950
RS-BS SWGR1	Black-grey	1	3.700	6120952
RS-BS AL1	Aluminium painted	1	3.700	6120954

PC Polycarbonate

Roller blind switch with electrical and mechanical lock, 1-pin, 10 A, 250 V~, with screwless terminals.

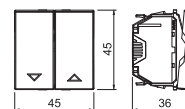

Changeover switch, 1/2 module

Type	Colour	Pack. pcs	Weight kg/100 pcs.	Item No.
TA-WB RW0.5	Pure white	1	1.800	6120960
TA-WB SWGR0.5	Black-grey	1	1.800	6120962
TA-WB AL0.5	Aluminium painted	1	1.800	6120964

PC Polycarbonate

Changeover switch, 1-pin, 10 A, 250 V~, with screwless terminals.

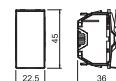

Changeover switch, 1 module

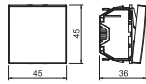

Type	Colour	Pack. Weight		Item No.
		pcs	kg/100 pcs.	
TA-WB RW1	Pure white	1	3.300	6120966
TA-WB SWGR1	Black-grey	1	3.300	6120968
TA-WB AL1	Aluminium painted	1	3.300	6120970

PC Polycarbonate

Changeover switch, 1-pin, 10 A, 250 V~, with screwless terminals.

Roller blind button, 1 module

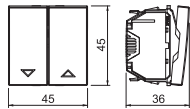

Type	Colour	Pack. Weight		Item No.
		pcs	kg/100 pcs.	
RT-BS RW1	Pure white	1	3.700	6120980
RT-BS SWGR1	Black-grey	1	3.700	6120982
RT-BS AL1	Aluminium painted	1	3.700	6120984

PC Polycarbonate

Roller blind button with electrical locking, 1-pin, 10 A, 250 V~, with screwless terminals.

Adapter for switch installation rotated through 90°

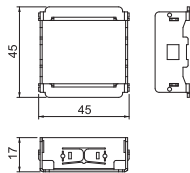

Type	Pack. Weight		Item No.
	pcs	kg/100 pcs.	
AD-90G M45-1	1	2.200	6120992

St Steel

The adapter allows switch installation rotated through 90° in, for example, service poles with a 45 mm track or Rapid 45. Suitable for all switches and buttons in one module width (45 x 45 mm).

Data technology support, 1 module, straight outlet, type RM

Type	Colour	Pack. pcs	Weight kg/100 pcs.	Item No.
DTG-2RM RW1	Pure white	1	1.100	6119292
DTG-2RM SWGR1	Black-grey	1	1.100	6119294
DTG-2RM AL1	Aluminium painted	1	1.100	6119296

PC Polycarbonate

The type RM data technology support is suitable for accepting the following data connection modules: Types ASM-C5, ASM-C5 G, ASM-C6 and ASM-C6 G; R&M: Cat.5 and Cat.6 modules with-out support plate.

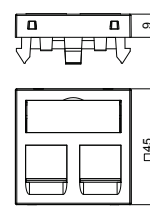

Data technology support, 1 module, slanting outlet, type RM

Type	Colour	Pack. pcs	Weight kg/100 pcs.	Item No.
DTS-2RM RW1	Pure white	1	2.900	6119298
DTS-2RM SWGR1	Black-grey	1	2.900	6119300
DTS-2RM AL1	Aluminium painted	1	2.900	6119302

PC Polycarbonate

The type RM data technology support is suitable for accepting the following data connection modules: Types ASM-C5, ASM-C5 G, ASM-C6 and ASM-C6 G; R&M: Cat.5 and Cat.6 modules with-out support plate.

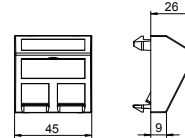

RJ45 data connection module, Cat. 5e, unshielded

Type	Pack. pcs	Weight kg/100 pcs.	Item No.
ASM-C5	1	1.120	6117337

Connection module Cat. 5e unshielded, with a RJ 45 slot. Including a dust cover, a cable tie and mounting instructions. Suitable for installation in data technology supports of type DTG-2RM and DTS-2RM.

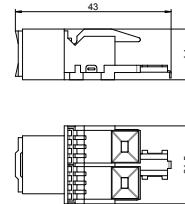

RJ45 data connection module, Cat. 5e, shielded

Type	Pack. pcs	Weight kg/100 pcs.	Item No.
ASM-C5 G	1	2.660	6117325

Connection module Cat. 5e shielded, with a RJ 45 slot. Includes an EMC screen hood, a dust cover, a cable tie and mounting instructions. Suitable for installation in data technology supports of type DTG-2RM and DTS-2RM.

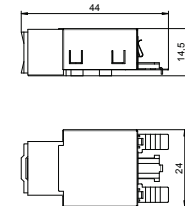

RJ45 data connection module, Cat. 6, unshielded

Type	Pack. pcs	Weight kg/100 pcs.	Item No.
ASM-C6	1	1.060	6117341

Connection module Cat. 6 unshielded, with a RJ 45 slot. Including a dust cover, a cable tie and mounting instructions. Suitable for installation in data technology supports of type DTG-2RM and DTS-2RM.

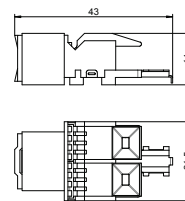

RJ45 data connection module, Cat. 6, shielded

Type	Pack. pcs	Weight kg/100 pcs.	Item No.
ASM-C6 G	1	1.850	6117329

Connection module Cat. 6 shielded, with a RJ 45 slot. Includes an EMC screen hood, a dust cover, a cable tie and mounting instructions. Suitable for installation in data technology supports of type DTG-2RM and DTS-2RM.

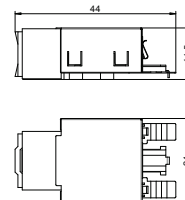

Data technology support, 1 module, straight outlet, type C

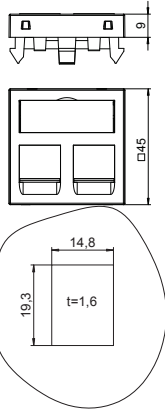

Type	Colour	Pack.	Weight	Item No.
		pcs	kg/100 pcs.	
DTG-2C RW1	Pure white	1	1.100	6119214
DTG-2C SWGR1	Black-grey	1	1.100	6119216
DTG-2C AL1	Aluminium painted	1	1.100	6119218

PC Polycarbonate

The type C data technology support is suitable for accepting the following data connection modules: BTR (Keystone design): Cat. 6A module and UAE module; Corning: modules with Keystone seat; CobiNet: CobiDat KS module; Dätwyler: KS-T, KS-TS, MS-K and KU-T; EKU: E-Stone; Harting: Prelink Keystone Cat. 6A; Fixlink Keystone Cat. 6A; Komos: KDM 500 module; Leoni Kerpen: MegaLine-Connect45 Keystone socket modules; OBO: Type ASM-C6A and ASM-C6A G; R&M: Cat. 6A with Keystone fastening; Rutenbeck: UM and UMflex; SETEC: UKJ and XKJ; Telegärtner: AMJ and UMJ.

Data technology support, 1 module, slanting outlet, type C

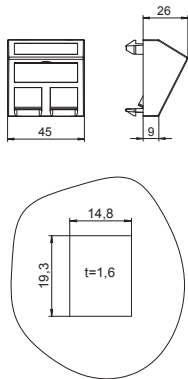

Type	Colour	Pack.	Weight	Item No.
		pcs	kg/100 pcs.	
DTS-2C RW1	Pure white	1	1.500	6119250
DTS-2C SWGR1	Black-grey	1	1.500	6119252
DTS-2C AL1	Aluminium painted	1	1.500	6119254

PC Polycarbonate

The type C data technology support is suitable for accepting the following data connection modules: BTR (Keystone design): Cat. 6A module and UAE module; Corning: modules with Keystone seat; CobiNet: CobiDat KS module; Dätwyler: KS-T, KS-TS, MS-K and KU-T; EKU: E-Stone; Harting: Prelink Keystone Cat. 6A; Fixlink Keystone Cat. 6A; Komos: KDM 500 module; Leoni Kerpen: MegaLine-Connect45 Keystone socket modules; OBO: Type ASM-C6A and ASM-C6A G; R&M: Cat. 6A with Keystone fastening; Rutenbeck: UM and UMflex; SETEC: UKJ and XKJ; Telegärtner: AMJ and UMJ.

Connection module Cat. 6A, unshielded, snap-in

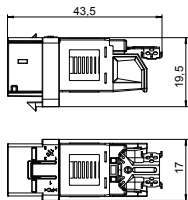

Type	Pack.	Weight	Item No.
	pcs	kg/100 pcs.	
ASM-C6A	1	1.050	6117348

Connection module Cat. 6A (ISO) unshielded, with an RJ45 slot. Including a dust cover, a cable tie, a Keystone fastening frame and mounting instructions. Suitable for installation in the data technology supports of type DTG-2C and DTS-2C, support plate of type MTM 2C and MTM 3C, mounting plate of type MPR2 2C, mounting supports of type MTGE2 2C, MTGE2 15 2C and MTGE2 F 2C.

Connection module Cat. 6A, shielded, snap-in

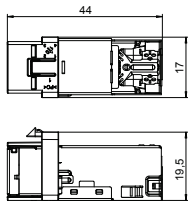

Type	Pack.	Weight	Item No.
	pcs	kg/100 pcs.	
ASM-C6A G	1	1.630	6117346

Connection module Cat. 6A (ISO) shielded, with an RJ45 slot. Including an EMC screen hood, a dust cover, a cable tie, a Keystone fastening frame and mounting instructions. Suitable for installation in the data technology supports of type DTG-2C and DTS-2C, support plate of type MTM 2C and MTM 3C, mounting plate of type MPR2 2C, mounting supports of type MTGE2 2C, MTGE2 15 2C and MTGE2 F 2C.

Connection module Cat. 5, unshielded, snap-in

Type	Pack. pcs	Weight kg/100 pcs.	Item No.
ASM-C5 S	1	1.120	6117347

Connection module Cat. 5e unshielded, with a RJ45 slot. Including a dust cover, a cable tie, a snap-in fastening frame and mounting instructions. Suitable for installation in support plates, type MTM 2C and MTM 3C, mounting plate type MPR2 2C, mounting support type MTGE2 2C, MTGE2 15 2C and MTGE2 F 2C.

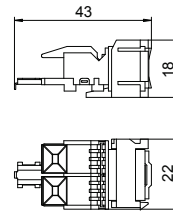

Data technology support, 1 module, straight outlet, type A

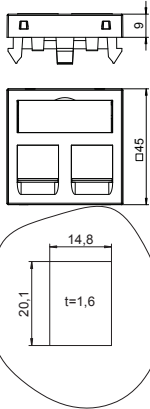

Type	Colour	Pack.	Weight	Item No.
		pcs	kg/100 pcs.	
DTG-2A RW1	Pure white	1	1.100	6119202
DTG-2A SWGR1	Black-grey	1	1.100	6119204
DTG-2A AL1	Aluminium painted	1	1.100	6119206

PC Polycarbonate

Data technology support with straight outlet and locking slider to accept two data technology connection modules with RJ45 socket. The locking fastening is suitable for horizontal and vertical installation in the system environment. Type A has a mounting opening of 20.10 x 14.80 mm and is designed for direct fastening of the data connection modules in the mounting opening.

The Type A data technology support is suitable for accepting the following data connection modules: AMP TYCO (without dust protection cap): SL Series 110Connect and SL Series Toolless; Brand-Rex: modules with item numbers ending in ...JAKS000CR and ...JAKU002; Nexans: LANmark RJ45 with blue adapter clip, LANmark GG45 with metal clip.

Data technology support, 1 module, slanting outlet, type A

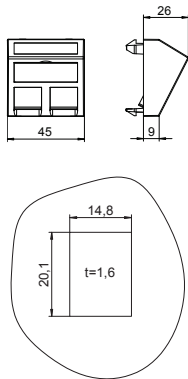

Type	Colour	Pack.	Weight	Item No.
		pcs	kg/100 pcs.	
DTS-2A RW1	Pure white	1	2.000	6119238
DTS-2A SWGR1	Black-grey	1	1.500	6119240
DTS-2A AL1	Aluminium painted	1	1.500	6119242

PC Polycarbonate

Data technology support with slanting outlet and locking slider to accept two data technology connection modules with RJ45 socket. The locking fastening is suitable for horizontal and vertical installation in the system environment. Type A has a mounting opening of 20.10 x 14.80 mm and is designed for direct fastening of the data connection modules in the mounting opening.

The Type A data technology support is suitable for accepting the following data connection modules: AMP TYCO (without dust protection cap): SL Series 110Connect and SL Series Toolless; Brand-Rex: modules with item numbers ending in ...JAKS000CR and ...JAKU002; Nexans: LANmark RJ45 with blue adapter clip, LANmark GG45 with metal clip.

Data technology support, 1 module, straight outlet, type B

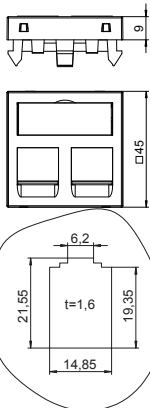

Type	Colour	Pack.	Weight	Item No.
		pcs	kg/100 pcs.	
DTG-2B RW1	Pure white	1	1.100	6119208
DTG-2B SWGR1	Black-grey	1	1.100	6119210
DTG-2B AL1	Aluminium painted	1	1.100	6119212

PC Polycarbonate

Data technology support with straight outlet and locking slider to accept two data technology connection modules with RJ45 socket. The locking fastening is suitable for horizontal and vertical installation in the system environment. Type B has a mounting opening of 19.35/21.55 x 14.85 mm and is designed for direct fastening of the data connection modules in the mounting opening.

The type B data technology support is suitable for accepting the following data connection modules: BTR (module design): Cat. 6A Modul, E-DAT module and UAE module; Dätwyler: MS and MS-N, Leoni Kerpen: VarioKeystone socket module Cat. 6A and MegaLine-Connect100 socket module Cat. 6A and 8C7A.

Data technology support, 1 module, slanting outlet, type B

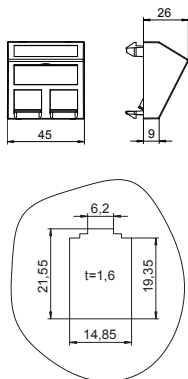

Type	Colour	Pack.	Weight	Item No.
		pcs	kg/100 pcs.	
DTS-2B RW1	Pure white	1	1.500	6119244
DTS-2B SWGR1	Black-grey	1	1.500	6119246
DTS-2B AL1	Aluminium painted	1	1.500	6119248

PC Polycarbonate

Data technology support with slanting outlet and locking slider to accept two data technology connection modules with RJ45 socket. The locking fastening is suitable for horizontal and vertical installation in the system environment. Type B has a mounting opening of 19.35/21.55 x 14.85 mm and is designed for direct fastening of the data connection modules in the mounting opening.

The type B data technology support is suitable for accepting the following data connection modules: BTR (module design): Cat. 6A Modul, E-DAT module and UAE module; Dätwyler: MS and MS-N, Leoni Kerpen: VarioKeystone socket module Cat. 6A and MegaLine-Connect100 socket module Cat. 6A and 8C7A.

Data technology support, 1 module, straight outlet, type C

Type	Colour	Pack. pcs	Weight		Item No.
			kg/100	pcs.	
DTG-2C RW1	Pure white	1	1.100		6119214
DTG-2C SWGR1	Black-grey	1	1.100		6119216
DTG-2C AL1	Aluminium painted	1	1.100		6119218

PC Polycarbonate

Data technology support with straight outlet and locking slider to accept two data technology connection modules with RJ45 socket. The locking fastening is suitable for horizontal and vertical installation in the system environment. Type C has a mounting opening of 19.30 x 14.80 mm and is designed for direct fastening of the data connection modules in the mounting opening.

The type C data technology support is suitable for accepting the following data connection modules: BTR (Keystone design): Cat. 6A module and UAE module; Corning: modules with Keystone seat; CobiNet: CobiDat KS module; Dätwyler: KS-T, KS-TS, MS-K and KU-T; EKU: E-Stone; Harting: Prelink Keystone Cat. 6A; Fixlink Keystone Cat. 6A; Komos: KDM 500 module; Leoni Kerpen: MegaLine-Connect45 Keystone socket modules; OBO: Type ASM-C6A and ASM-C6A G; R&M: Cat. 6A with Keystone fastening; Rutenbeck: UM and UMflex; SETEC: UKJ and XKJ; Telegärtner: AMJ and UMJ.

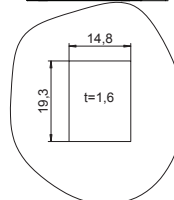
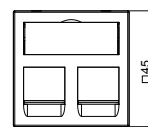
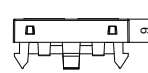

Data technology support, 1 module, slanting outlet, type C

Type	Colour	Pack. pcs	Weight		Item No.
			kg/100	pcs.	
DTS-2C RW1	Pure white	1	1.500		6119250
DTS-2C SWGR1	Black-grey	1	1.500		6119252
DTS-2C AL1	Aluminium painted	1	1.500		6119254

PC Polycarbonate

Data technology support with slanting outlet and locking slider to accept two data technology connection modules with RJ45 socket. The locking fastening is suitable for horizontal and vertical installation in the system environment. Type C has a mounting opening of 19.30 x 14.80 mm and is designed for direct fastening of the data connection modules in the mounting opening.

The type C data technology support is suitable for accepting the following data connection modules: BTR (Keystone design): Cat. 6A module and UAE module; Corning: modules with Keystone seat; CobiNet: CobiDat KS module; Dätwyler: KS-T, KS-TS, MS-K and KU-T; EKU: E-Stone; Harting: Prelink Keystone Cat. 6A; Fixlink Keystone Cat. 6A; Komos: KDM 500 module; Leoni Kerpen: MegaLine-Connect45 Keystone socket modules; OBO: Type ASM-C6A and ASM-C6A G; R&M: Cat. 6A with Keystone fastening; Rutenbeck: UM and UMflex; SETEC: UKJ and XKJ; Telegärtner: AMJ and UMJ.

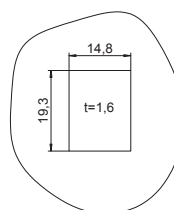
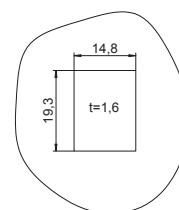
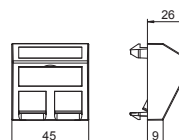

Data technology support, 1 module, straight outlet, type C, without dust protection slider

Type	Colour	Pack. pcs	Weight		Item No.
			kg/100	pcs.	
DTG-02C RW1	Pure white	1	1.000		6119280
DTG-02C SWGR1	Black-grey	1	1.000		6119282
DTG-02C AL1	Aluminium painted	1	1.000		6119284

PC Polycarbonate

Data technology support with straight outlet and without a locking slider to accept two data technology connection modules with RJ45 socket. The locking fastening is suitable for horizontal and vertical installation in the system environment. Type C has a mounting opening of 19.30 x 14.80 mm and is designed for direct fastening of the data connection modules in the mounting opening.

The type C data technology support (without dust protection slider) is suitable for accepting the following data connection modules: 3M: Volition K6, K10 and Cat. 6A.

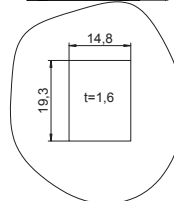
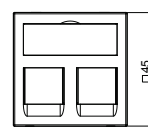
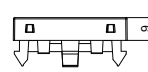

Data technology support, 1 module, slanting outlet, type C, without dust protection slider

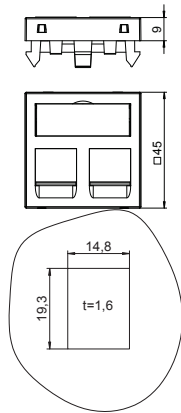

Type	Colour	Pack. pcs	Weight kg/100 pcs.	Item No.
DTS-02C RW1	Pure white	1	1.400	6119286
DTS-02C SWGR1	Black-grey	1	1.400	6119288
DTS-02C AL1	Aluminium painted	1	1.400	6119290

PC Polycarbonate

Data technology support with slanting outlet and without a locking slider to accept two data technology connection modules with RJ45 socket. The locking fastening is suitable for horizontal and vertical installation in the system environment. Type C has a mounting opening of 19.30 x 14.80 mm and is designed for direct fastening of the data connection modules in the mounting opening.

The type C data technology support (without dust protection slider) is suitable for accepting the following data connection modules: 3M: Volition K6, K10 and Cat. 6A.

Data technology support, 1 module, straight outlet, type EP

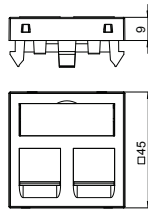

Type	Colour	Pack. pcs	Weight kg/100 pcs.	Item No.
DTG-2EP RW1	Pure white	1	1.100	6119232
DTG-2EP SWGR1	Black-grey	1	1.100	6119234
DTG-2EP AL1	Aluminium painted	1	1.100	6119236

PC Polycarbonate

Data technology support with straight outlet and locking slider to accept two data technology connection modules with RJ45 socket. The locking fastening is suitable for horizontal and vertical installation in the system environment. Type EP has a special module seat and is designed for indirect fastening of the data connection modules in the mounting opening.

The type EP data technology support is suitable for accepting the following data connection modules: Leoni Kerpen: MegaLine-Connect45 ELine.

Data technology support, 1 module, slanting outlet, type EP

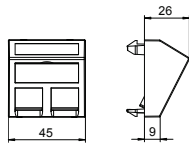

Type	Colour	Pack. pcs	Weight kg/100 pcs.	Item No.
DTS-2EP RW1	Pure white	1	1.500	6119268
DTS-2EP SWGR1	Black-grey	1	1.500	6119270
DTS-2EP AL1	Aluminium painted	1	1.500	6119272

PC Polycarbonate

Data technology support with slanting outlet and locking slider to accept two data technology connection modules with RJ45 socket. The locking fastening is suitable for horizontal and vertical installation in the system environment. Type EP has a special module seat and is designed for indirect fastening of the data connection modules in the mounting opening.

The type EP data technology support is suitable for accepting the following data connection modules: Leoni Kerpen: The type EP data technology support is suitable for accepting the following data connection modules: Leoni Kerpen: MegaLine-Connect45 ELine.

Data technology support, 1 module, straight outlet, type F

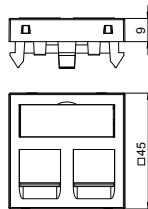

Type	Colour	Pack. pcs	Weight kg/100 pcs.	Item No.
DTG-2F RW1	Pure white	1	1.100	6119220
DTG-2F SWGR1	Black-grey	1	1.100	6119222
DTG-2F AL1	Aluminium painted	1	1.100	6119224

PC Polycarbonate

Data technology support with straight outlet and locking slider to accept two data technology connection modules. The locking fastening is suitable for horizontal and vertical installation in the system environment.

The type F data technology support is suitable for accepting the following data connection modules: Avaya/Systimax: M series.



Data technology support, 1 module, slanting outlet, type F

Type	Colour	Pack. pcs	Weight		Item No.
			kg/100	pcs.	
DTS-2F RW1	Pure white	1	1.500		6119256
DTS-2F SWGR1	Black-grey	1	1.500		6119258
DTS-2F AL1	Aluminium painted	1	1.500		6119260

PC Polycarbonate

Data technology support with slanting outlet and locking slider to accept two data technology connection modules with RJ45 socket. The locking fastening is suitable for horizontal and vertical installation in the system environment. Type F has a special module seat and is designed for indirect fastening of the data connection modules in the mounting opening.

The type F data technology support is suitable for accepting the following data connection modules: Avaya/Systimax: M series.

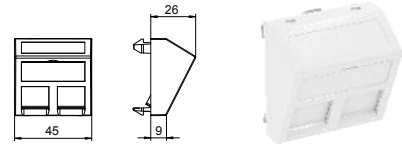

Data technology support, 1 module, straight outlet, type PA

Type	Colour	Pack. pcs	Weight		Item No.
			kg/100	pcs.	
DTG-2PA RW1	Pure white	1	1.100		6119226
DTG-2PA SWGR1	Black-grey	1	1.100		6119228
DTG-2PA AL1	Aluminium painted	1	1.100		6119230

PC Polycarbonate

Data technology support with straight outlet and locking slider to accept two data technology connection modules with RJ45 socket. The locking fastening is suitable for horizontal and vertical installation in the system environment. Type PA has a special module seat and is designed for indirect fastening of the data connection modules in the mounting opening.

The type PA data technology support is suitable for accepting the following data connection modules: Panduit: Mini-Com.

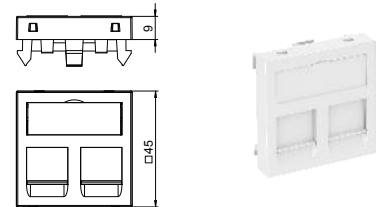

Data technology support, 1 module, slanting outlet, type PA

Type	Colour	Pack. pcs	Weight		Item No.
			kg/100	pcs.	
DTS-2PA RW1	Pure white	1	1.500		6119262
DTS-2PA SWGR1	Black-grey	1	1.500		6119264
DTS-2PA AL1	Aluminium painted	1	1.500		6119266

PC Polycarbonate

Data technology support with slanting outlet and locking slider to accept two data technology connection modules with RJ45 socket. The locking fastening is suitable for horizontal and vertical installation in the system environment. Type PA has a special module seat and is designed for indirect fastening of the data connection modules in the mounting opening.

The type PA data technology support is suitable for accepting the following data connection modules: Panduit: Mini-Com.

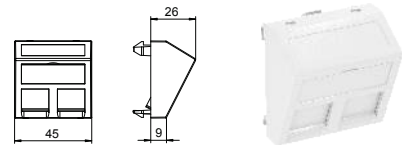

Data technology support, 1 module, straight outlet, type RM

Type	Colour	Pack. pcs	Weight		Item No.
			kg/100	pcs.	
DTG-2RM RW1	Pure white	1	1.100		6119292
DTG-2RM SWGR1	Black-grey	1	1.100		6119294
DTG-2RM AL1	Aluminium painted	1	1.100		6119296

PC Polycarbonate

Data technology support with straight outlet and locking slider to accept two data technology connection modules with RJ45 socket. The locking fastening is suitable for horizontal and vertical installation in the system environment. Type RM has a special module seat and is designed for indirect fastening of the data connection modules in the mounting opening.

The type RM data technology support is suitable for accepting the following data connection modules: Types ASM-C5, ASM-C5 G, ASM-C6 and ASM-C6 G; R&M: Cat.5 and Cat.6 modules without support plate.

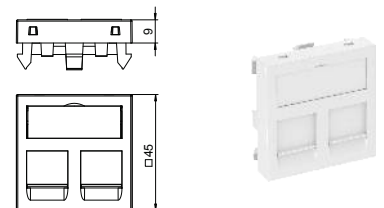

EGS_Typ_0A / en / 2019/04/10 12:33:19 (LLExpert_02375) / 2019/04/10 12:33:42 12:33:42

Modul 45® devices



Data technology support, 1 module, slanting outlet, type RM

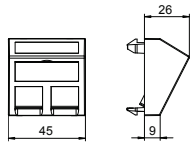

Type	Colour	Pack.	Weight	Item No.
		pcs	kg/100 pcs.	
DTS-2RM RW1	Pure white	1	2.900	6119298
DTS-2RM SWGR1	Black-grey	1	2.900	6119300
DTS-2RM AL1	Aluminium painted	1	2.900	6119302

PC Polycarbonate

Data technology support with slanting outlet and locking slider to accept two data technology connection modules with RJ45 socket. The locking fastening is suitable for horizontal and vertical installation in the system environment. Type RM has a special module seat and is designed for indirect fastening of the data connection modules in the mounting opening.

The type RM data technology support is suitable for accepting the following data connection modules: Types ASM-C5, ASM-C5 G, ASM-C6 and ASM-C6 G; R&M: Cat.5 and Cat.6 modules without support plate.

Data technology support, 1 module, straight outlet, type LE

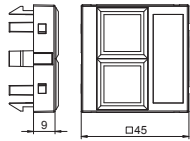

Type	Colour	Pack.	Weight	Item No.
		pcs	kg/100 pcs.	
DTG-02LE RW1	Pure white	1	0.900	6119304
DTG-02LE SWGR1	Black-grey	1	0.900	6119306
DTG-02LE AL1	Aluminium painted	1	0.900	6119308

PC Polycarbonate

Data technology support with straight outlet and without a locking slider to accept two data technology connection modules with RJ45 socket. The locking fastening is suitable for horizontal and vertical installation in the system environment. Type LE has a special module seat and is designed for indirect fastening of the data connection modules in the mounting opening.

The type LE data technology support is suitable for accepting the following data connection modules: LexCom/Schneider: LexCom 125, LexCom 250 and LexCom 500.



Multimedia support for VGA / D-Sub9 plug connector, 1 module, straight outlet

Type	Colour	Pack. pcs	Weight kg/100 pcs.	Item No.
MTG-DB O RW1	Pure white	1	0.700	6104706
MTG-DB O SWGR1	Black-grey	1	0.700	6104709
MTG-DB O AL1	Aluminium painted	1	0.700	6104712

PC Polycarbonate

Multimedia support for a VGA / D-Sub9 plug connector, straight cable outlet, with labelling panel, without plug connector. Support plate with locking fastening, suitable for horizontal and vertical installation in the system environment.

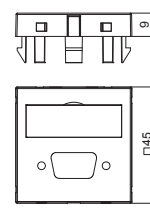

Multimedia support for VGA / D-Sub9 plug connector, 1 module, slanting outlet

Type	Colour	Pack. pcs	Weight kg/100 pcs.	Item No.
MTS-DB O RW1	Pure white	1	0.900	6104718
MTS-DB O SWGR1	Black-grey	1	0.900	6104721
MTS-DB O AL1	Aluminium painted	1	0.900	6104724

PC Polycarbonate

Multimedia support for a VGA / D-Sub9 plug connector, slanting cable outlet, with labelling panel, without plug connector. Support plate with locking fastening, suitable for horizontal and vertical installation in the system environment.

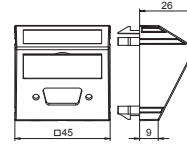

Multimedia support for DVI plug connector, 1 module, straight outlet

Type	Colour	Pack. pcs	Weight kg/100 pcs.	Item No.
MTG-DV O RW1	Pure white	1	0.700	6104778
MTG-DV O SWGR1	Black-grey	1	0.700	6104781
MTG-DV O AL1	Aluminium painted	1	0.700	6104784

PC Polycarbonate

Multimedia support for a DVI plug connector, straight cable outlet, with labelling panel, without plug connector. Support plate with locking fastening, suitable for horizontal and vertical installation in the system environment.

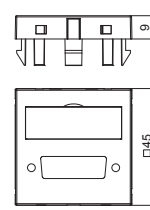

Multimedia support for DVI plug connector, 1 module, slanting outlet

Type	Colour	Pack. pcs	Weight kg/100 pcs.	Item No.
MTS-DV O RW1	Pure white	1	0.900	6104790
MTS-DV O SWGR1	Black-grey	1	0.900	6104793
MTS-DV O AL1	Aluminium painted	1	0.900	6104796

PC Polycarbonate

Multimedia support for a DVI plug connector, slanting cable outlet, with labelling panel, without plug connector. Support plate with locking fastening, suitable for horizontal and vertical installation in the system environment.

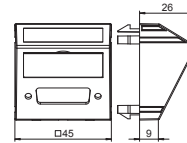

Multimedia support for SLR plug connector, 1 module, straight outlet

Type	Colour	Pack. pcs	Weight kg/100 pcs.	Item No.
MTG-X O RW1	Pure white	1	0.600	6105234
MTG-X O SWGR1	Black-grey	1	0.600	6105237
MTG-X O AL1	Aluminium painted	1	0.600	6105240

PC Polycarbonate

Multimedia support for a XLR plug connector, straight cable outlet, without labelling panel, without plug connector. Support plate with locking fastening, suitable for horizontal and vertical installation in the system environment.

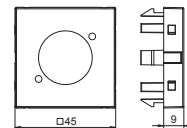

D-Sub9 connection, 1 module, straight outlet, as screw connection

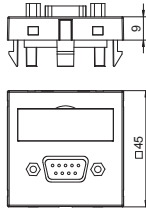

Type	Colour	Pack. pcs	Weight kg/100 pcs.	Item No.
MTG-DB9 S RW1	Pure white	1	2.400	6104634
MTG-DB9 S SWGR1	Black-grey	1	2.400	6104637
MTG-DB9 S AL1	Aluminium painted	1	2.400	6104640

PC Polycarbonate

Multimedia support with one D-Sub9 connection socket, straight cable outlet, with labelling panel, D-Sub9 socket (RS232) with screw connection. Support plate with locking fastening, suitable for horizontal and vertical installation in the system environment.

D-Sub9 connection, 1 module, slanting outlet, as screw connection

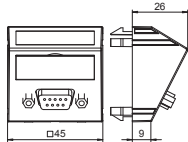

Type	Colour	Pack. pcs	Weight kg/100 pcs.	Item No.
MTS-DB9 S RW1	Pure white	1	2.600	6104646
MTS-DB9 S SWGR1	Black-grey	1	2.600	6104649
MTS-DB9 S AL1	Aluminium painted	1	2.600	6104652

PC Polycarbonate

Multimedia support with one D-Sub9 connection socket, slanting cable outlet, with labelling panel, D-Sub9 socket (RS232) with screw connection. Support plate with locking fastening, suitable for horizontal and vertical installation in the system environment.

D-Sub9 connection, 1 module, straight outlet, with connection cable

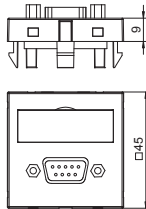

Type	Colour	Pack. pcs	Weight kg/100 pcs.	Item No.
MTG-DB9 F RW1	Pure white	1	5.200	6104682
MTG-DB9 F SWGR1	Black-grey	1	5.200	6104685
MTG-DB9 F AL1	Aluminium painted	1	5.200	6104688

PC Polycarbonate

Multimedia support with one D-Sub9 connection socket, straight cable outlet, with labelling panel, short D-Sub9 connection cable (RS232), socket-socket version. Support with locking fastening, suitable for horizontal and vertical installation in the system environment.

D-Sub9 connection, 1 module, slanting outlet, with connection cable

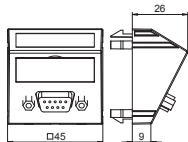

Type	Colour	Pack. pcs	Weight kg/100 pcs.	Item No.
MTS-DB9 F RW1	Pure white	1	5.400	6104694
MTS-DB9 F SWGR1	Black-grey	1	5.400	6104697
MTS-DB9 F AL1	Aluminium painted	1	5.400	6104700

PC Polycarbonate

Multimedia support with one D-Sub9 connection socket, slanting cable outlet, with labelling panel, short D-Sub9 connection cable (RS232), socket-socket version. Support with locking fastening, suitable for horizontal and vertical installation in the system environment.

USB 2.0 / 3.0 connection, 1 module, straight outlet, as screw connection

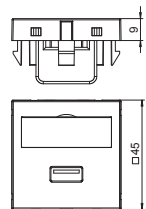

Type	Colour	Pack. pcs	Weight kg/100 pcs.	Item No.
MTG-U3A S RW1	Pure white	1	2.500	6104874
MTG-U3A S SWGR1	Black-grey	1	2.500	6104877
MTG-U3A S AL1	Aluminium painted	1	2.500	6104880

PC Polycarbonate

Multimedia support with one USB 3.0 connection socket, straight cable outlet, with labelling panel, USB 3.0 Type A socket with screw connection. Support plate with locking fastening, suitable for horizontal and vertical installation in the system environment.

USB 2.0 / 3.0 connection, 1 module, slanting outlet, as screw connection

Type	Colour	Pack. pcs	Weight kg/100 pcs.	Item No.
MTS-U3A S RW1	Pure white	1	2.700	6104886
MTS-U3A S SWGR1	Black-grey	1	2.700	6104889
MTS-U3A S AL1	Aluminium painted	1	2.700	6104892

PC Polycarbonate

Multimedia support with one USB 3.0 connection socket, slanting cable outlet, with labelling panel, USB 3.0 type A socket with screw connection. Support plate with locking fastening, suitable for horizontal and vertical installation in the system environment.

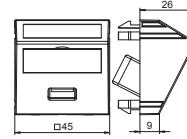

USB 2.0 / 3.0 connection, 1 module, straight outlet, with connection cable

Type	Colour	Pack. pcs	Weight kg/100 pcs.	Item No.
MTG-U3A F RW1	Pure white	1	6.000	6104922
MTG-U3A F SWGR1	Black-grey	1	6.000	6104925
MTG-U3A F AL1	Aluminium painted	1	6.000	6104928

PC Polycarbonate

Multimedia support with one USB 3.0 connection socket, straight cable outlet, with labelling panel, short USB 3.0 type A connection cable, socket-socket version. Support plate with locking fastening, suitable for horizontal and vertical installation in the system environment.

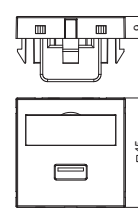

USB 2.0 / 3.0 connection, 1 module, slanting outlet, with connection cable

Type	Colour	Pack. pcs	Weight kg/100 pcs.	Item No.
MTS-U3A F RW1	Pure white	1	6.200	6104934
MTS-U3A F SWGR1	Black-grey	1	6.200	6104937
MTS-U3A F AL1	Aluminium painted	1	6.200	6104940

PC Polycarbonate

Multimedia support with one USB 3.0 connection socket, slanting cable outlet, with labelling panel, short USB 3.0 type A connection cable, socket-socket version. Support plate with locking fastening, suitable for horizontal and vertical installation in the system environment.

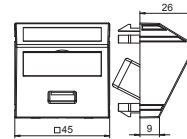

DVI-D connection, 1 module, straight outlet, as screw connection

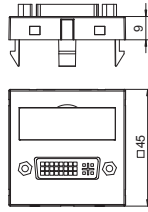

Type	Colour	Pack. pcs	Weight kg/100 pcs.	Item No.
MTG-DVI S RW1	Pure white	1	3.500	6104730
MTG-DVI S SWGR1	Black-grey	1	3.500	6104733
MTG-DVI S AL1	Aluminium painted	1	3.500	6104736

PC Polycarbonate

Multimedia support with one DVI-D connection socket, straight cable outlet, with labelling panel, DVI-D socket with screw connection. Support plate with locking fastening, suitable for horizontal and vertical installation in the system environment.

Note: Due to the device dimensions, device installation in Rapid 45 device installation trunking is not possible.

DVI-D connection, 1 module, slanting outlet, as screw connection

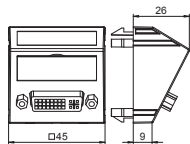

Type	Colour	Pack. pcs	Weight kg/100 pcs.	Item No.
MTS-DVI S RW1	Pure white	1	3.700	6104742
MTS-DVI S SWGR1	Black-grey	1	3.700	6104745
MTS-DVI S AL1	Aluminium painted	1	3.700	6104748

PC Polycarbonate

Multimedia support with one DVI-D connection socket, slanting cable outlet, with labelling panel, DVI-D socket with screw connection. Support plate with locking fastening, suitable for horizontal and vertical installation in the system environment.

DVI-I connection, 1 module, straight outlet, with connection cable

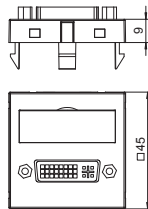

Type	Colour	Pack. pcs	Weight kg/100 pcs.	Item No.
MTG-DVI F RW1	Pure white	1	6.000	6104754
MTG-DVI F SWGR1	Black-grey	1	6.000	6104757
MTG-DVI F AL1	Aluminium painted	1	6.000	6104760

PC Polycarbonate

Multimedia support with one DVI-I connection socket, straight cable outlet, with labelling panel, short DVI-I connection cable, socket-socket version. Support with locking fastening, suitable for horizontal and vertical installation in the system environment.

DVI-I connection, 1 module, slanting outlet, with connection cable

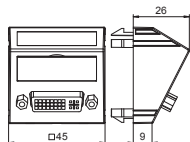

Type	Colour	Pack. pcs	Weight kg/100 pcs.	Item No.
MTS-DVI F RW1	Pure white	1	6.200	6104766
MTS-DVI F SWGR1	Black-grey	1	6.200	6104769
MTS-DVI F AL1	Aluminium painted	1	6.200	6104772

PC Polycarbonate

Multimedia support with one DVI-I connection socket, slanting cable outlet, with labelling panel, short DVI-I connection cable, socket-socket version. Support with locking fastening, suitable for horizontal and vertical installation in the system environment.

HDMI connection, 1 module, straight outlet, as screw connection

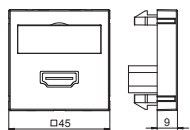

Type	Colour	Pack. pcs	Weight kg/100 pcs.	Item No.
MTG-HD S RW1	Pure white	1	3.200	6104802
MTG-HD S SWGR1	Black-grey	1	3.200	6104805
MTG-HD S AL1	Aluminium painted	1	3.200	6104808

PC Polycarbonate

Multimedia support with one HDMI connection socket, straight cable outlet, with labelling panel, HDMI socket with screw connection. Support plate with locking fastening, suitable for horizontal and vertical installation in the system environment.

Note: Due to the device dimensions, device installation in Rapid 45 device installation ducts and ISSR..45 / ISSD..45 service poles is not possible.

HDMI connection, 1 module, slanting outlet, as screw connection

Type	Colour	Pack. pcs	Weight		Item No.
			kg/100	pcs.	
MTS-HD S RW1	Pure white	1	3.400		6104814
MTS-HD S SWGR1	Black-grey	1	3.400		6104817
MTS-HD S AL1	Aluminium painted	1	3.400		6104820

PC Polycarbonate

Multimedia support with one HDMI connection socket, slanting cable outlet, with labelling panel, HDMI socket with screw connection. Support plate with locking fastening, suitable for horizontal and vertical installation in the system environment.

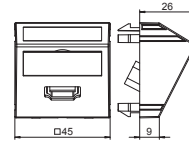

HDMI connection, 1 module, straight outlet, with connection cable

Type	Colour	Pack. pcs	Weight		Item No.
			kg/100	pcs.	
MTG-HD F RW1	Pure white	1	6.000		6104826
MTG-HD F SWGR1	Black-grey	1	6.000		6104829
MTG-HD F AL1	Aluminium painted	1	6.000		6104832

PC Polycarbonate

Multimedia support with one HDMI connection socket, straight cable outlet, with labelling panel, short HDMI connection cable, socket-socket version. Support plate with locking fastening, suitable for horizontal and vertical installation in the system environment.

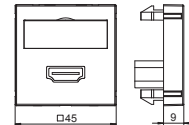

HDMI connection, 1 module, slanting outlet, with connection cable

Type	Colour	Pack. pcs	Weight		Item No.
			kg/100	pcs.	
MTS-HD F RW1	Pure white	1	6.200		6104838
MTS-HD F SWGR1	Black-grey	1	6.200		6104841
MTS-HD F AL1	Aluminium painted	1	6.200		6104844

PC Polycarbonate

Multimedia support with one HDMI connection socket, slanting cable outlet, with labelling panel, short HDMI connection cable, socket-socket version. Support plate with locking fastening, suitable for horizontal and vertical installation in the system environment.

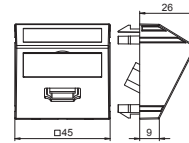

VGA connection, 1 module, straight outlet, as screw connection

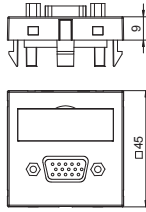

Type	Colour	Pack. pcs	Weight kg/100 pcs.	Item No.
MTG-VGA S RW1	Pure white	1	2.400	6104610
MTG-VGA S SWGR1	Black-grey	1	2.400	6104613
MTG-VGA S AL1	Aluminium painted	1	2.400	6104616

PC Polycarbonate

Multimedia support with one VGA connection socket, straight cable outlet, with labelling panel, VGA socket (HD15) with screw connection. Support plate with locking fastening, suitable for horizontal and vertical installation in the system environment.

VGA connection, 1 module, slanting outlet, as screw connection

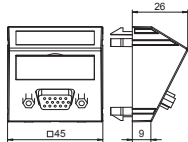

Type	Colour	Pack. pcs	Weight kg/100 pcs.	Item No.
MTS-VGA S RW1	Pure white	1	2.600	6104622
MTS-VGA S SWGR1	Black-grey	1	2.600	6104625
MTS-VGA S AL1	Aluminium painted	1	2.600	6104628

PC Polycarbonate

Multimedia support with one VGA connection socket, slanting cable outlet, with labelling panel, VGA socket (HD15) with screw connection. Support plate with locking fastening, suitable for horizontal and vertical installation in the system environment.

VGA connection, 1 module, straight outlet, with connection cable

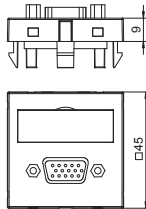

Type	Colour	Pack. pcs	Weight kg/100 pcs.	Item No.
MTG-VGA F RW1	Pure white	1	5.200	6104658
MTG-VGA F SWGR1	Black-grey	1	5.200	6104661
MTG-VGA F AL1	Aluminium painted	1	5.200	6104664

PC Polycarbonate

Multimedia support with one VGA connection socket, straight cable outlet, with labelling panel, short VGA connection cable (HD15), socket-socket version. Support with locking fastening, suitable for horizontal and vertical installation in the system environment.

VGA connection, 1 module, slanting outlet, with connection cable

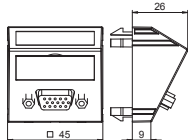

Type	Colour	Pack. pcs	Weight kg/100 pcs.	Item No.
MTS-VGA F RW1	Pure white	1	5.400	6104670
MTS-VGA F SWGR1	Black-grey	1	5.400	6104673
MTS-VGA F AL1	Aluminium painted	1	5.400	6104676

PC Polycarbonate

Multimedia support with one VGA connection socket, slanting cable outlet, with labelling panel, short VGA connection cable (HD15), socket-socket version. Support with locking fastening, suitable for horizontal and vertical installation in the system environment.

Mini jack connection, 1 module, straight outlet, as soldered connection

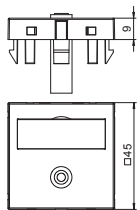

Type	Colour	Pack. pcs	Weight kg/100 pcs.	Item No.
MTG-MK L RW1	Pure white	1	1.500	6104946
MTG-MK L SWGR1	Black-grey	1	1.500	6104949
MTG-MK L AL1	Aluminium painted	1	1.500	6104952

PC Polycarbonate

Multimedia support with one mini jack connection socket, straight cable outlet, with labelling panel, mini cinch socket (TRS 3.5 mm) with soldered connection. Support plate with locking fastening, suitable for horizontal and vertical installation in the system environment.

Mini jack connection, 1 module, slanting outlet, as soldered connection

Type	Colour	Pack. pcs	Weight kg/100 pcs.	Item No.
MTS-MK L RW1	Pure white	1	1.700	6104958
MTS-MK L SWGR1	Black-grey	1	1.700	6104961
MTS-MK L AL1	Aluminium painted	1	1.700	6104964

PC Polycarbonate

Multimedia support with one mini jack connection socket, slanting cable outlet, with labelling panel, mini cinch socket (TRS 3.5 mm) with soldered connection. Support plate with locking fastening, suitable for horizontal and vertical installation in the system environment.

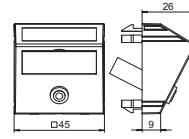

Video cinch connection, 1 module, straight outlet, as soldered connection

Type	Colour	Pack. pcs	Weight kg/100 pcs.	Item No.
MTG-R L RW1	Pure white	1	1.500	6104970
MTG-R L SWGR1	Black-grey	1	1.500	6104973
MTG-R L AL1	Aluminium painted	1	1.500	6104976

PC Polycarbonate

Multimedia support with one cinch connection socket for composite video, straight cable outlet, with labelling panel, cinch socket (RCA) with soldered connection, colour coding yellow. Support plate with locking fastening, suitable for horizontal and vertical installation in the system environment.

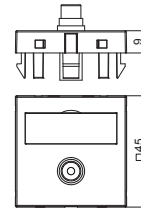

Video cinch connection, 1 module, slanting outlet, as soldered connection

Type	Colour	Pack. pcs	Weight kg/100 pcs.	Item No.
MTS-R L RW1	Pure white	1	1.700	6104982
MTS-R L SWGR1	Black-grey	1	1.700	6104985
MTS-R L AL1	Aluminium painted	1	1.700	6104988

PC Polycarbonate

Multimedia support with one cinch connection socket for composite video, slanting cable outlet, with labelling panel, cinch socket (RCA) with soldered connection, colour coding yellow. Support plate with locking fastening, suitable for horizontal and vertical installation in the system environment.

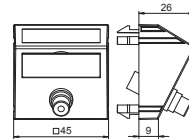

Video cinch connection, 1 module, straight outlet, as 1:1 coupling

Type	Colour	Pack. pcs	Weight kg/100 pcs.	Item No.
MTG-R F RW1	Pure white	1	1.500	6104994
MTG-R F SWGR1	Black-grey	1	1.500	6104997
MTG-R F AL1	Aluminium painted	1	1.500	6105000

PC Polycarbonate

Multimedia support with one cinch connection socket for composite video, straight cable outlet, with labelling panel, cinch coupling (RCA), socket-socket version, colour coding yellow. Support plate with locking fastening, suitable for horizontal and vertical installation in the system environment.

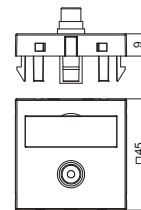

Video cinch connection, 1 module, slanting outlet, as 1:1 coupling

Type	Colour	Pack. pcs	Weight kg/100 pcs.	Item No.
MTS-R F RW1	Pure white	1	1.700	6105006
MTS-R F SWGR1	Black-grey	1	1.700	6105009
MTS-R F AL1	Aluminium painted	1	1.700	6105012

PC Polycarbonate

Multimedia support with one cinch connection socket for composite video, slanting cable outlet, with labelling panel, cinch coupling (RCA), socket-socket version, colour coding yellow. Support plate with locking fastening, suitable for horizontal and vertical installation in the system environment.

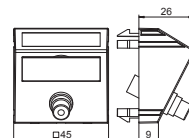

Audio cinch connection, 1 module, straight outlet, as soldered connection

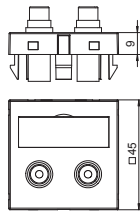

Type	Colour	Pack. pcs	Weight kg/100 pcs.	Item No.
MTG-2R L RW1	Pure white	1	2.500	6105042
MTG-2R L SWGR1	Black-grey	1	2.500	6105045
MTG-2R L AL1	Aluminium painted	1	2.500	6105048

PC Polycarbonate

Multimedia support with two cinch connection sockets for audio R/L, straight cable outlet, with labelling panel, two cinch sockets (RCA) with soldered connection, colour coding red/white. Support plate with locking fastening, suitable for horizontal and vertical installation in the system environment.

Audio cinch connection, 1 module, slanting outlet, as soldered connection

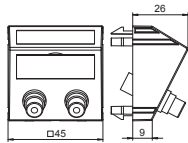

Type	Colour	Pack. pcs	Weight kg/100 pcs.	Item No.
MTS-2R L RW1	Pure white	1	2.700	6105054
MTS-2R L SWGR1	Black-grey	1	2.700	6105057
MTS-2R L AL1	Aluminium painted	1	2.700	6105060

PC Polycarbonate

Multimedia support with two cinch connection sockets for audio R/L, slanting cable outlet, with labelling panel, two cinch sockets (RCA) with soldered connection, colour coding red/white. Support plate with locking fastening, suitable for horizontal and vertical installation in the system environment.

Audio cinch connection, 1 module, straight outlet, as 1:1 coupling

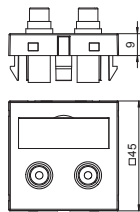

Type	Colour	Pack. pcs	Weight kg/100 pcs.	Item No.
MTG-2R F RW1	Pure white	1	2.500	6105066
MTG-2R F SWGR1	Black-grey	1	2.500	6105069
MTG-2R F AL1	Aluminium painted	1	2.500	6105072

PC Polycarbonate

Multimedia support with two cinch connection sockets for audio R/L, straight cable outlet, with labelling panel, two cinch couplings (RCA), socket-socket version, colour coding red/white. Support plate with locking fastening, suitable for horizontal and vertical installation in the system environment.

Audio cinch connection, 1 module, slanting outlet, as 1:1 coupling

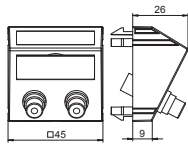

Type	Colour	Pack. pcs	Weight kg/100 pcs.	Item No.
MTS-2R F RW1	Pure white	1	2.700	6105078
MTS-2R F SWGR1	Black-grey	1	2.700	6105081
MTS-2R F AL1	Aluminium painted	1	2.700	6105084

PC Polycarbonate

Multimedia support with two cinch connection sockets for audio R/L, slanting cable outlet, with labelling panel, two cinch couplings (RCA), socket-socket version, colour coding red/white. Support plate with locking fastening, suitable for horizontal and vertical installation in the system environment.

Component video connection, 1 module, straight outlet, as soldered connection

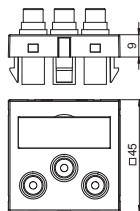

Type	Colour	Pack. pcs	Weight kg/100 pcs.	Item No.
MTG-3R L RW1	Pure white	1	3.200	6105114
MTG-3R L SWGR1	Black-grey	1	3.200	6105117
MTG-3R L AL1	Aluminium painted	1	3.200	6105120

PC Polycarbonate

Multimedia support with three cinch connection sockets for component video, straight cable outlet, with labelling panel, three cinch sockets (RCA) with soldered connection, colour coding red / green / blue. Support plate with locking fastening, suitable for horizontal and vertical installation in the system environment.

Component video connection, 1 module, slanting outlet, as soldered connection

Type	Colour	Pack. pcs	Weight kg/100 pcs.	Item No.
MTS-3R L RW1	Pure white	1	3.400	6105126
MTS-3R L SWGR1	Black-grey	1	3.400	6105129
MTS-3R L AL1	Aluminium painted	1	3.400	6105132

PC Polycarbonate

Multimedia support with three cinch connection sockets for component video, slanting cable outlet, with labelling panel, three cinch sockets (RCA) with soldered connection, colour coding red / green / blue. Support plate with locking fastening, suitable for horizontal and vertical installation in the system environment.

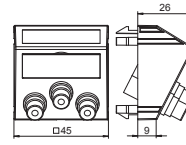

Component video connection, 1 module, straight outlet, as 1:1 coupling

Type	Colour	Pack. pcs	Weight kg/100 pcs.	Item No.
MTG-3R F RW1	Pure white	1	3.200	6105138
MTG-3R F SWGR1	Black-grey	1	3.200	6105141
MTG-3R F AL1	Aluminium painted	1	3.200	6105144

PC Polycarbonate

Multimedia support with three cinch connection sockets for component video, straight cable outlet, with labelling panel, three cinch couplings (RCA), socket-socket version, colour coding red / green / blue. Support plate with locking fastening, suitable for horizontal and vertical installation in the system environment.

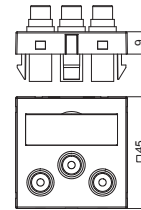

Component video connection, 1 module, slanting outlet, as 1:1 coupling

Type	Colour	Pack. pcs	Weight kg/100 pcs.	Item No.
MTS-3R F RW1	Pure white	1	3.400	6105150
MTS-3R F SWGR1	Black-grey	1	3.400	6105153
MTS-3R F AL1	Aluminium painted	1	3.400	6105156

PC Polycarbonate

Multimedia support with three cinch connection sockets for component video, slanting cable outlet, with labelling panel, three cinch couplings (RCA), socket-socket version, colour coding red / green / blue. Support plate with locking fastening, suitable for horizontal and vertical installation in the system environment.

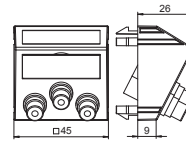

Audio/video cinch connection, 1 module, straight outlet, as soldered connection

Type	Colour	Pack. pcs	Weight kg/100 pcs.	Item No.
MTG-12R L RW1	Pure white	1	3.200	6105162
MTG-12R L SWGR1	Black-grey	1	3.200	6105165
MTG-12R L AL1	Aluminium painted	1	3.200	6105168

PC Polycarbonate

Multimedia support with three cinch connection sockets for audio-video, straight cable outlet, with labelling panel, three cinch sockets (RCA) with soldered connection, colour coding yellow / red / white. Support plate with locking fastening, suitable for horizontal and vertical installation in the system environment.

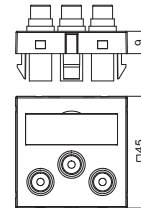

Audio/video cinch connection, 1 module, slanting outlet, as soldered connection

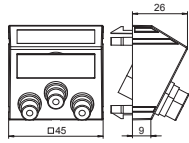

Type	Colour	Pack. pcs	Weight kg/100 pcs.	Item No.
MTS-12R L RW1	Pure white	1	3.400	6105174
MTS-12R L SWGR1	Black-grey	1	3.400	6105177
MTS-12R L AL1	Aluminium painted	1	3.400	6105180

PC Polycarbonate

Multimedia support with three cinch connection sockets for audio/video, slanting cable outlet, with labelling panel, three cinch sockets (RCA) with soldered connection, colour coding yellow / red / white. Support plate with locking fastening, suitable for horizontal and vertical installation in the system environment.

Audio/video cinch connection, 1 module, straight outlet, as 1:1 coupling

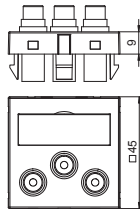

Type	Colour	Pack. pcs	Weight kg/100 pcs.	Item No.
MTG-12R F RW1	Pure white	1	3.200	6105186
MTG-12R F SWGR1	Black-grey	1	3.200	6105189
MTG-12R F AL1	Aluminium painted	1	3.200	6105192

PC Polycarbonate

Multimedia support with three cinch connection sockets for audio/video, straight cable outlet, with labelling panel, three cinch couplings (RCA), socket-socket version, colour coding yellow / red / white. Support plate with locking fastening, suitable for horizontal and vertical installation in the system environment.

Audio/video cinch connection, 1 module, slanting outlet, as 1:1 coupling

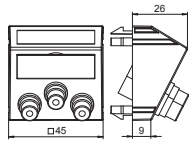

Type	Colour	Pack. pcs	Weight kg/100 pcs.	Item No.
MTS-12R F RW1	Pure white	1	3.400	6105198
MTS-12R F SWGR1	Black-grey	1	3.400	6105201
MTS-12R F AL1	Aluminium painted	1	3.400	6105204

PC Polycarbonate

Multimedia support with three cinch connection sockets for audio/video, slanting cable outlet, with labelling panel, three cinch couplings (RCA), socket-socket version, colour coding yellow / red / white. Support plate with locking fastening, suitable for horizontal and vertical installation in the system environment.

XLR connection, 1 module, straight outlet, 3-pin socket, as soldered connection

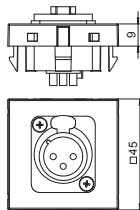

Type	Colour	Pack. pcs	Weight kg/100 pcs.	Item No.
MTG-X3F L RW1	Pure white	1	3.000	6105210
MTG-X3F L SWGR1	Black-grey	1	3.000	6105213
MTG-X3F L AL1	Aluminium painted	1	3.000	6105216

PC Polycarbonate

Multimedia support with one XLR connection socket, straight cable outlet, without labelling panel, 3-pin XLR socket with soldered connection. Support plate with locking fastening, suitable for horizontal and vertical installation in the system environment.

XLR connection, 1 module, straight outlet, 3-pin connector, as soldered connection

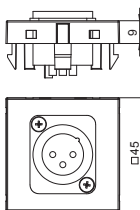

Type	Colour	Pack. pcs	Weight kg/100 pcs.	Item No.
MTG-X3M L RW1	Pure white	1	3.000	6105222
MTG-X3M L SWGR1	Black-grey	1	3.000	6105225
MTG-X3M L AL1	Aluminium painted	1	3.000	6105228

PC Polycarbonate

Multimedia support with one XLR connection socket, straight cable outlet, without labelling panel, 3-pin XLR connector with soldered connection. Support plate with locking fastening, suitable for horizontal and vertical installation in the system environment.



XLR connection, 1 module, straight outlet, 3-pin socket, as screw connection

Type	Colour	Pack. pcs	Weight kg/100 pcs.	Item No.
MTG-X3F S RW1	Pure white	1	3.500	6105250
MTG-X3F S SWGR1	Black-grey	1	3.500	6105252
MTG-X3F S AL1	Aluminium painted	1	3.500	6105254

PC Polycarbonate

Multimedia support with one XLR connection socket, straight cable outlet, without labelling panel, XLR 3-pin socket with screw connection. Support plate with locking fastening, suitable for horizontal and vertical installation in the system environment.

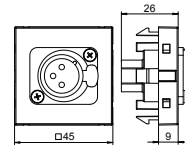

XLR connection, 1 module, straight outlet, 3-pin connection, as screw connection

Type	Colour	Pack. pcs	Weight kg/100 pcs.	Item No.
MTG-X3M S RW1	Pure white	1	3.500	6105258
MTG-X3M S SWGR1	Black-grey	1	3.500	6105260
MTG-X3M S AL1	Aluminium painted	1	3.500	6105262

PC Polycarbonate

Multimedia support with one XLR connection socket, straight cable outlet, without labelling panel, XLR 3-pin socket with screw connection. Support plate with locking fastening, suitable for horizontal and vertical installation in the system environment.

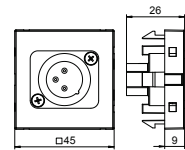

Speakon connection, 1 module, straight outlet, 4-pin socket, as screw connection

Type	Colour	Pack. pcs	Weight kg/100 pcs.	Item No.
MTG-SON S RW1	Pure white	1	2.800	6105270
MTG-SON S SWGR1	Black-grey	1	2.800	6105272
MTG-SON S AL1	Aluminium painted	1	2.800	6105274

PC Polycarbonate

Multimedia support with one Speakon connection socket, straight cable outlet, without labelling panel, Speakon 4-pin socket with screw connection. Support plate with locking fastening, suitable for horizontal and vertical installation in the system environment.

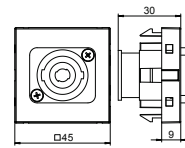

BNC connection, 1 module, straight outlet, as 1:1 coupling

Type	Colour	Pack. pcs	Weight kg/100 pcs.	Item No.
MTG-BC F RW1	Pure white	1	1.500	6105018
MTG-BC F SWGR1	Black-grey	1	1.500	6105021
MTG-BC F AL1	Aluminium painted	1	1.500	6105024

PC Polycarbonate

Multimedia support with one BNC connection socket, straight cable outlet, with labelling panel, BNC cinch coupling, socket-socket version. Support plate with locking fastening, suitable for horizontal and vertical installation in the system environment.

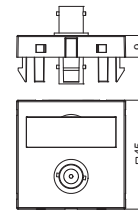

BNC connection, 1 module, slanting outlet, as 1:1 coupling

Type	Colour	Pack. pcs	Weight kg/100 pcs.	Item No.
MTS-BC F RW1	Pure white	1	1.700	6105030
MTS-BC F SWGR1	Black-grey	1	1.700	6105033
MTS-BC F AL1	Aluminium painted	1	1.700	6105036

PC Polycarbonate

Multimedia support with one BNC connection socket, slanting cable outlet, with labelling panel, BNC cinch coupling, socket-socket version. Support plate with locking fastening, suitable for horizontal and vertical installation in the system environment.

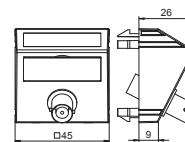

2 x BNC connection, 1 module, straight outlet, as 1:1 coupling

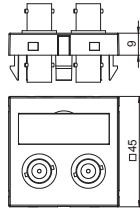

Type	Colour	Pack. pcs	Weight kg/100 pcs.	Item No.
MTG-2BC F RW1	Pure white	1	2.500	6105090
MTG-2BC F SWGR1	Black-grey	1	2.500	6105093
MTG-2BC F AL1	Aluminium painted	1	2.500	6105096

PC Polycarbonate

Multimedia support with two BNC connection sockets, straight cable outlet, with labelling panel, two BNC couplings, socket-socket version. Support plate with locking fastening, suitable for horizontal and vertical installation in the system environment.

2 x BNC connection, 1 module, slanting outlet, as 1:1 coupling

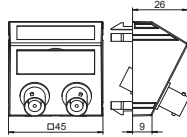

Type	Colour	Pack. pcs	Weight kg/100 pcs.	Item No.
MTS-2BC F RW1	Pure white	1	2.700	6105102
MTS-2BC F SWGR1	Black-grey	1	2.700	6105105
MTS-2BC F AL1	Aluminium painted	1	2.700	6105108

PC Polycarbonate

Multimedia support with two BNC connection sockets, slanting cable outlet, with labelling panel, two BNC couplings, socket-socket version. Support plate with locking fastening, suitable for horizontal and vertical installation in the system environment.

Antenna connection, 1 module, TV / radio / SAT, antenna socket

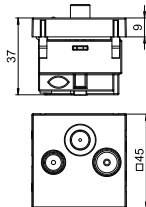

Type	Colour	Pack. pcs	Weight kg/100 pcs.	Item No.
ANT-3SD RW1	Pure white	1	11.596	6105282
ANT-3SD SWGR1	Black-grey	1	11.596	6105284
ANT-3SD AL1	Aluminium painted	1	11.000	6105286

PC Polycarbonate

Socket for antenna, BK and satellite reception systems with connection for TV and radio.

Frequency: 5–2150 MHz
 Heat attenuation: 5-862 MHz - 1 dB
 950-2150 MHz - 2 dB
 Return channel attenuation: 14 dB
 EMC protection class A

Equipotential bonding socket, 1 module, straight outlet

Type	Colour	Pack. pcs	Weight kg/100 pcs.	Item No.
PAD-ID6 RW1	Pure white	1	5.000	6120003
PAD-ID6 SWGR1	Black-grey	1	5.000	6120001
PAD-ID6 AL1	Aluminium painted	1	5.000	6120005

PC Polycarbonate

Equipotential bonding socket to DIN 42801, socket in black with green-yellow colour ring, cable connection to rear with M6 screw bolt, including two nuts, washers and a serrated washer.

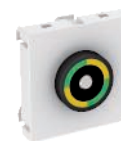
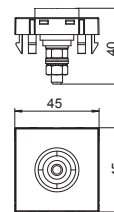

Cable outlet for 3–11 mm cross-section

Type	Colour	Pack. pcs	Weight kg/100 pcs.	Item No.
KAL-K11 RW1	Pure white	1	3.500	6117420
KAL-K11 SWGR1	Black-grey	1	3.500	6117421
KAL-K11 AL1	Aluminium painted	1	3.500	6117422

PC Polycarbonate

Two-part cable outlet with labelling panel, consisting of a cable support with strain relief and a cover. The strain relief is suited for cable cross-sections of 3 to 11 mm. The locking fastening is suitable for horizontal and vertical installation in the system environment.

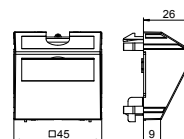

Blanking cover with labelling panel, 1/2 module

Type	Colour	Pack. pcs	Weight kg/100 pcs.	Item No.
ADP-BF RW0.5	Pure white	1	0.400	6117410
ADP-BF SWGR0.5	Black-grey	1	0.400	6117411
ADP-BF AL0.5	Aluminium painted	1	0.400	6117412

PC Polycarbonate

Blanking cover with labelling panel, suited for labelling devices in Rapid 45 device installation trunking systems and ISS service poles with a 45 mm system opening.

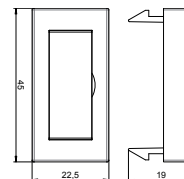

Blanking cover, 1/2 module

Type	Colour	Pack. pcs	Weight kg/100 pcs.	Item No.
ADP-B RW0.5	Pure white	10	0.400	6117414
ADP-B SWGR0.5	Black-grey	10	0.400	6117415
ADP-B AL0.5	Aluminium painted	1	0.400	6117416

Blanking cover for closing off empty spaces for a half device (1/2 module).

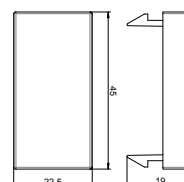

Blanking cover, 1 module

Type	Colour	Pack. pcs	Weight kg/100 pcs.	Item No.
ADP-B RW1	Pure white	10	0.800	6117406
ADP-B SWGR1	Black-grey	10	0.800	6117407
ADP-B AL1	Aluminium painted	1	0.800	6117408

Blanking cover for closing off empty spaces for a device (one module).

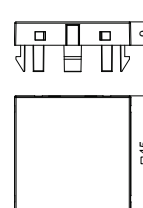

Surface-mounted housing



Modul 45® – device installation solutions for surface and concealed mounting

The Modul net system is designed for the installation of Modul 45 devices and can be used for surface-mounted or cavity wall installations. The installation housing, which has a modular structure, can also be easily adjusted to the required number of installation devices. The basic configuration offers space for 4 Modul 45 installation devices. The housing can be expanded as required using an expansion module for 2 Modul 45 installation devices.

For installations in cavity walls, matching cavity wall supports and screen frames are available as accessories. Installations with 4 devices (2x 2x) and 6 installation devices (3x 2x) are possible.



Cavity wall installation





Modul 45® – device installation solutions for surface and concealed mounting



Modul 45®, modal net installation housing

54



Modul 45®, Modal net surface-mounted housing

Surface-mounted housing, basic configuration, 2x double

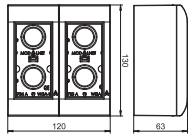

Type	Colour	Pack. Weight		Item No.
		pcs	kg/100 pcs.	
WG-AK RW	Pure white	1	35.000	6109900
PC Polycarbonate				

Basic configuration consisting of two housing bases (right and left side) with two cover frames to accept of Modul 45 accessories of 2x module width = 90 mm.

Surface-mounted housing, expansion module, double

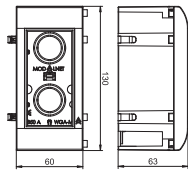

Type	Colour	Pack. Weight		Item No.
		pcs	kg/100 pcs.	
WG-MK RW	Pure white	1	17.500	6109905
PC Polycarbonate				

Extension module consisting of housing base and cover frame to accept Modul 45 accessories of 2x module width = 90 mm.

Cover frame, double, for protective equipment installation

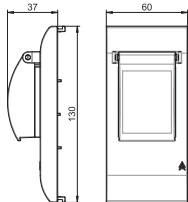

Type	Colour	Pack. Weight		Item No.
		pcs	kg/100 pcs.	
WG-AF2TE RW	Pure white	1	7.500	6109932
PC Polycarbonate				

Construction set, protection unit installation consisting of cover with mounting support and transparent cover hood. Allows the installation of protective equipment (two units) such as miniature circuit-breakers or FI protection switches in the Modal net housing.

Support for cavity wall installation 2x double

Type	Pack. pcs	Weight kg/100 pcs.	Item No.
WG-UK2	1	31.000	6109950

- St** Steel
- FS** Strip-galvanised

Metal cavity wall support to accept the Modul net housing .

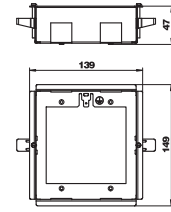

Screen frame for cavity wall installation 2x double

Type	Colour	Pack. pcs	Weight kg/100 pcs.	Item No.
WG-UBR2 RW	Pure white	1	4.400	6109934

- PC** Polycarbonate

Screen frame for placing on the cavity wall support .

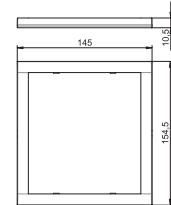

Support for cavity wall installation 3x double

Type	Pack. pcs	Weight kg/100 pcs.	Item No.
WG-UK3	1	35.000	6109952

- St** Steel
- FS** Strip-galvanised

Metal cavity wall support to accept the Modul net housing .

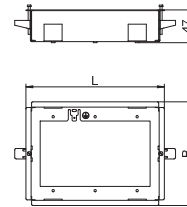

Screen frame for cavity wall installation 3x double

Type	Colour	Pack. pcs	Weight kg/100 pcs.	Item No.
WG-UBR3 RW	Pure white	1	4.500	6109936

- PC** Polycarbonate

Screen frame for placing on the cavity wall support .

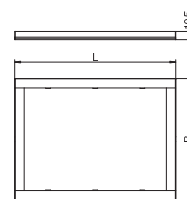



Modul 45® and standard – installation solutions for device installation ducts and service poles with 80 mm system opening



The Modul 45 devices from OBO Bettermann are compact and space-saving. They are therefore ideal for use in device installation ducts and service poles. The Modul 45 system makes optimum use of limited installation space.

The advantages of Modul 45 at a glance:

- Space savings thanks to compact design
- Modular structure
- Quick and easy planning
- Simple mounting
- High efficiency due to time and cost savings
- Wide range of application options
- Easy exchangeability



Modul 45® and standard – Installation solutions for device installation ducts and service poles

	Modul 45®, Pre-terminated installation units for 80 mm trunking systems	58
	Modul 45®, device installation in 80 mm trunking systems	62
	Standard, device installation in 80 mm trunking systems	65

Socket unit AR45, single

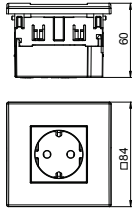

Type	Colour	Pack. pcs	Weight kg/100 pcs.	Item No.
SDE-RW D0RW1	Pure white	4	10.700	6119401
SDE-RW D0GN1	Mint green	4	10.700	6119402
SDE-RW D0RT1	Signal red	4	10.700	6119403

PC Polycarbonate

Pre-terminated socket unit without labelling panel, suitable for installation in Rapid 80 device installation trunking systems. Socket unit, consisting of:

- Service outlet, single, type 71GD8-2.
- Protective contact socket, single, 0° connection direction, colour: see table.
- Cover frame AR45, single, without labelling panel, colour: pure white

Socket unit AR45, double

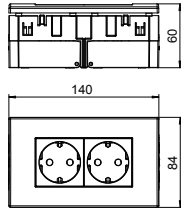

Type	Colour	Pack. pcs	Weight kg/100 pcs.	Item No.
SDE-RW D0RW2	Pure white	2	19.000	6119407
SDE-RW D0GN2	Mint green	2	19.000	6119408
SDE-RW D0RT2	Signal red	2	19.000	6119409

PC Polycarbonate

Pre-terminated socket unit without labelling panel, suitable for installation in Rapid 80 device installation trunking systems. Socket unit, consisting of:

- Service outlet, double, type 71GD13
- Protective contact socket, double, 0° connection direction, colour: see table
- Cover frame AR45, double, without labelling panel, type AR45-BF..., colour: pure white

Socket unit AR45, triple

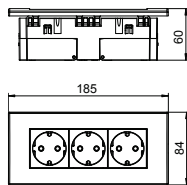

Type	Colour	Pack. pcs	Weight kg/100 pcs.	Item No.
SDE-RW D0RW3	Pure white	2	23.300	6119414
SDE-RW D0GN3	Mint green	2	23.300	6119415
SDE-RW D0RT3	Signal red	2	23.300	6119413

PC Polycarbonate

Pre-terminated socket unit without labelling panel, suitable for installation in Rapid 80 device installation trunking systems. Socket unit, consisting of:

- Service outlet, triple, type 71GD9-2
- Protective contact socket, triple, 0° connection direction, colour: see table
- Cover frame AR45, triple, without labelling panel, type AR45-BF..., colour: pure white

Socket unit AR45, single, with labelling panel for horizontal device installation

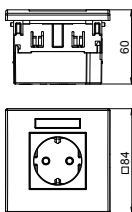

Type	Colour	Pack. pcs	Weight kg/100 pcs.	Item No.
SDE-RW D0RW1B	Pure white	4	10.700	6119421
SDE-RW D0GN1B	Mint green	4	10.700	6119422
SDE-RW D0RT1B	Signal red	4	10.700	6119423

PC Polycarbonate

Pre-terminated socket unit with labelling panel, suitable for installation in Rapid 80 device installation trunking systems. Socket unit, consisting of:

- Service outlet, single, type 71GD8-2
- Protective contact socket, single, 0° connection direction, colour: see table
- Cover frame AR45, single, with labelling panel, type AR45-BF..., colour: pure white

Socket unit AR45, double, with labelling panel for horizontal device installation

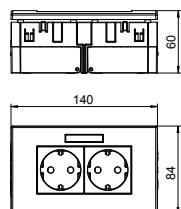

Type	Colour	Pack. pcs	Weight kg/100 pcs.	Item No.
SDE-RW D0RW2B	Pure white	2	19.000	6119427
SDE-RW D0GN2B	Mint green	2	19.000	6119428
SDE-RW D0RT2B	Signal red	2	19.000	6119429

PC Polycarbonate

Pre-terminated socket unit with labelling panel, suitable for installation in Rapid 80 device installation trunking systems. Socket unit, consisting of:

- Service outlet, double, type 71GD13
- Protective contact socket, double, 0° connection direction, colour: see table
- Cover frame AR45, double, with labelling panel, type AR45-BF..., colour: pure white

Socket unit AR45, triple, with labelling panel for horizontal device installation

Type	Colour	Pack. pcs	Weight kg/100 pcs.	Item No.
SDE-RW D0RW3B	Pure white	2	23.300	6119433
SDE-RW D0GN3B	Mint green	2	23.300	6119434
SDE-RW D0RT3B	Signal red	2	23.300	6119435

PC Polycarbonate

Pre-terminated socket unit with labelling panel, suitable for installation in Rapid 80 device installation trunking systems. Socket unit, consisting of:

- Service outlet, triple, type 71GD9-2
- Protective contact socket, triple, 0° connection direction, colour: see table
- Cover frame AR45, triple, with labelling panel, type AR45-BF..., colour: pure white

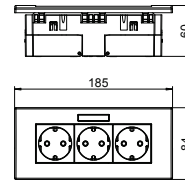

Accessory mounting box CEE, 16 A

Type	Colour	Pack. pcs	Weight kg/100 pcs.	Item No.
CEE16E2	Iron grey	1	34.110	6288612

PA Polyamide

Accessory mounting box, complete, for the installation of a CEE connection device in device installation trunking with 80 mm cover, consisting of:

- Front locking device installation trunking
- CEE connection unit and mounting material
- CEE socket 16 A

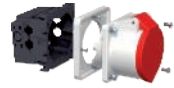
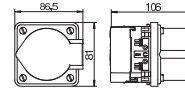

Socket unit CEE, single, 16 A

Type	Colour	Pack. pcs	Weight kg/100 pcs.	Item No.
71GDCEE16	Graphite black	1	31.100	6119483

PA Polyamide

Accessory mounting box for the installation of a 3 or 5-pole CEE socket, 16 A or 32 A.

Scope of delivery:

- 1 front-locking accessory mounting box for 4-point fastening track of 52 x 52 mm to 70 x 70 mm
- 1 cover frame in pure white for hiding the fastening technology
- 2 external strain reliefs for jacketed cables of up to Ø 18 mm
- 2 sash locks for optional fastening to trunking bases with C rail
- 1 CEE socket 16 A with mounting accessories

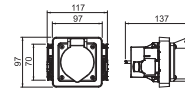

Socket unit CEE, single, 32 A

Type	Colour	Pack. pcs	Weight kg/100 pcs.	Item No.
71GDCEE32	Graphite black	1	37.200	6119485

PA Polyamide

Accessory mounting box for the installation of a 3 or 5-pole CEE socket, 16 A or 32 A.

Scope of delivery:

- 1 front-locking accessory mounting box for 4-point fastening track of 52 x 52 mm to 70 x 70 mm
- 1 cover frame in pure white for hiding the fastening technology
- 2 external strain reliefs for jacketed cables of up to Ø 18 mm
- 2 sash locks for optional fastening to trunking bases with C rail
- 1 CEE socket 32 A with mounting accessories

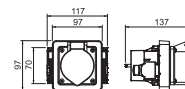

Preterminated installation unit for decentral protection

Installation unit AR45, for 2 PU

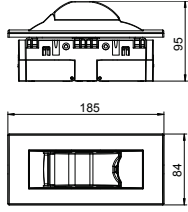

Type	Colour	Pack.	Weight	Item No.
		pcs	kg/100 pcs.	
IKR-6 RW	Pure white	1	19.000	6119319
PC	Polycarbonate			

Installation unit to accept protective units such as miniature circuit breakers or FI protection switches up to max. 2 PUs, suitable for installation in Rapid 80 device installation trunking systems and ISS service poles.

Installation unit, consisting of:

- Accessory mounting box, triple, type 71GD9-2
- Cover, incl. PVC support clamp for 2 PUs, colour: see table
- Cover frame AR45, triple, without labelling panel, colour: pure white

Flush-mount unit for data technology, type A

Type	Colour	Pack.		Weight	Item No.
		pcs	kg/100 pcs.		
DTE-RW G2A1	Pure white	4	5.000		6119494
PC Polycarbonate					

Flush-mount unit to accept two Type A data technology modules, suitable for installation in Rapid 80 device installation trunking systems and ISS service poles. The type A data technology support is suitable for accepting the following data connection modules: AMP TYCO (without dust protection cap): SL Series 110Connect and SL Series Toolless; Brand-Rex: modules with item numbers ending in ...JAKS000CR and ...JAKU002; Nexans: LANmark RJ45 with blue adapter clip, LANmark GG45 with metal clip.

Flush-mount unit, consisting of:

- Mounting support, single, type 71MT1 45
- Data technology support, straight outlet, type DTG-2A, colour: See table
- Cover frame AR45, single, without labelling panel, colour: Pure white

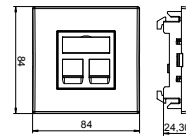

Flush-mount unit for data technology, type C

Type	Colour	Pack.		Weight	Item No.
		pcs	kg/100 pcs.		
DTE-RW G2C1	Pure white	4	5.000		6119492
PC Polycarbonate					

Flush-mount unit to accept two Type C data technology modules, suitable for installation in Rapid 80 device installation trunking systems and ISS service poles. The type C data technology support is suitable for accepting the following data connection modules: BTR (Keystone design): Cat. 6A module and UAE module; Corning: modules with Keystone seat; CobiNet: CobiDat KS module; Dätwyler: KS-T, KS-TS, MS-K and KU-T; EKV: E-Stone; Harting: Prelink Keystone Cat. 6A; Fixlink Keystone Cat. 6A; Komos: KDM 500 module; Leoni Kerpen: MegaLine Keystone Cat. 6A; OBO: Type ASM-C6A and ASM-C6A G; R&M: Cat. 6A with Keystone fastening; Rutenbeck: UM and UMflex; SETEC: UKJ and XKJ; Telegärtner: AMJ and UMJ.

Flush-mount unit, consisting of:

- Mounting support, single, type 71MT1 45
- Data technology support, straight outlet, type DTG-2C, colour: See table
- Cover frame AR45, single, without labelling panel, colour: Pure white

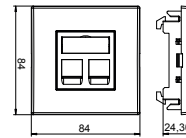

Flush-mount unit for data technology, type RM

Type	Colour	Pack.		Weight	Item No.
		pcs	kg/100 pcs.		
DTE-RW G2RM1	Pure white	4	5.000		6119490
PC Polycarbonate					

Flush-mount unit to accept two Type RM data technology modules, suitable for installation in Rapid 80 device installation trunking systems and ISS service poles. The type RM data technology support is suitable for accepting the following data connection modules: OBO (type): ASM-C5, ASM-C5 G, ASM-C6 and ASM-C6 G; R&M: Cat. 5 and Cat. 6 modules without support plate.

Flush-mount unit, consisting of:

- Mounting support, single, type 71MT1 45
- Data technology support, straight outlet, type DTG-2RM, colour: See table
- Cover frame AR45, single, without labelling panel, colour: Pure white

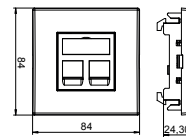

Modul 45®, device installation solution, single

Mounting support, single, for Modul 45®

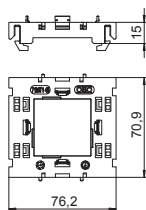

Type	Colour	Pack.	Weight	Item No.
		pcs	kg/100 pcs.	
71MT1 45	Light grey	10	2.000	6288572

PA Polyamide

Front locking single mounting support for Modul 45 data technology systems and Modul 45connect protective contact sockets with Wieland connection.

Cover frame AR45, single

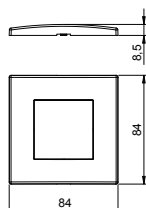

Type	Colour	Pack.	Weight	Item No.
		pcs	kg/100 pcs.	
AR45-F1 RW	Pure white	1	1.600	6119322
AR45-F1 SWGR	Black-grey	1	1.600	6119324
AR45-F1 AL	Aluminium painted	1	1.600	6119326

PC Polycarbonate

Front locking cover frame for Modul 45 devices, single, without labelling panel for horizontal and vertical device installation, for locking in accessory mounting box 71GD8-2.

Cover frame AR45, single, with labelling panel for horizontal device installation

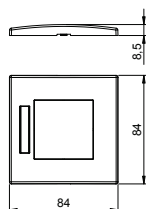

Type	Colour	Pack.	Weight	Item No.
		pcs	kg/100 pcs.	
AR45-BF1 RW	Pure white	1	1.500	6119332
AR45-BF1 SWGR	Black-grey	1	1.500	6119334
AR45-BF1 AL	Aluminium painted	1	1.500	6119336

PC Polycarbonate

Front locking cover frame for Modul 45 devices, single, with labelling panel for horizontal device installation, for locking in accessory mounting box 71GD8-2.

Cover frame AR45, single, with labelling panel for vertical device installation

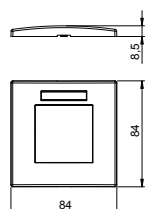

Type	Colour	Pack.	Weight	Item No.
		pcs	kg/100 pcs.	
AR45-BSF1 RW	Pure white	1	1.500	6119338
AR45-BSF1 SWGR	Black-grey	1	1.500	6119339
AR45-BSF1 AL	Aluminium painted	1	1.500	6119340

PC Polycarbonate

Front locking cover frame for Modul 45 devices, single, with labelling panel for vertical device installation, for locking in accessory mounting box 71GD8-2.

Mounting support, double, for Modul 45®

Type	Pack. pcs	Weight kg/100 pcs.	Item No.
71MT2 45	5	3.050	6288576

PA Polyamide

Front locking double mounting support for Modul 45 data technology systems and Modul 45connect protective contact sockets with Wieland connection.

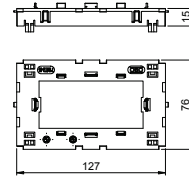

Cover frame AR45, double

Type	Colour	Pack. pcs	Weight kg/100 pcs.	Item No.
AR45-F2 RW	Pure white	1	2.320	6119342
AR45-F2 SWGR	Black-grey	1	2.320	6119344
AR45-F2 AL	Aluminium painted	1	2.320	6119346

PC Polycarbonate

Front locking cover frame for Modul 45 devices, single, without labelling panel for horizontal and vertical device installation, for locking in accessory mounting box 71GD13 or in mounting support 71MT2 45.

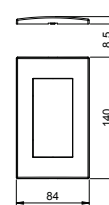

Cover frame AR45, double, with labelling panel for horizontal device installation

Type	Colour	Pack. pcs	Weight kg/100 pcs.	Item No.
AR45-BF2 RW	Pure white	1	2.260	6119352
AR45-BF2 SWGR	Black-grey	1	2.260	6119354
AR45-BF2 AL	Aluminium painted	1	2.260	6119356

PC Polycarbonate

Front locking cover frame for Modul 45 devices, double, with labelling panel for horizontal device installation, for locking in accessory mounting box 71GD13 or in mounting support 71MT2 45.

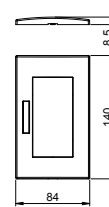

Cover frame AR45, double, with labelling panel for vertical device installation

Type	Colour	Pack. pcs	Weight kg/100 pcs.	Item No.
AR45-BSF2 RW	Pure white	1	2.260	6119362
AR45-BSF2 SWGR	Black-grey	1	2.260	6119364
AR45-BSF2 AL	Aluminium painted	1	2.260	6119366

PC Polycarbonate

Front locking cover frame for Modul 45 devices, double, with labelling panel for vertical device installation, for locking in accessory mounting box 71GD13 or in mounting support 71MT2 45.

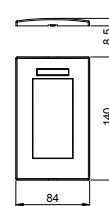

Modul 45®, device installation solution, triple

Mounting support, triple, for Modul 45®

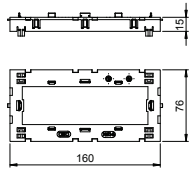

Type

71MT3 45-2

PA Polyamide

Front locking double/triple mounting support for Modul 45 data technology systems and Modul 45connect protective contact sockets with Wieland connection.

Type	Pack. Weight		Item No.
	pcs	kg/100 pcs.	
71MT3 45-2	5	3.200	6288574

Cover frame AR45, triple

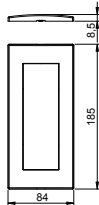

Type

Type	Colour	Pack. Weight		Item No.
		pcs	kg/100 pcs.	
AR45-F3 RW	Pure white	1	2.800	6119372
AR45-F3 SWGR	Black-grey	1	2.800	6119374
AR45-F3 AL	Aluminium painted	1	2.800	6119376

PC Polycarbonate

Front locking cover frame for Modul 45 devices, triple, without labelling panel for horizontal and vertical device installation, for locking in accessory mounting box 71GD9-2 or in mounting support 71MT3 45-2.

Cover frame AR45, triple, with labelling panel for horizontal device installation

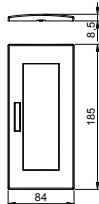

Type

Type	Colour	Pack. Weight		Item No.
		pcs	kg/100 pcs.	
AR45-BF3 RW	Pure white	1	2.800	6119382
AR45-BF3 SWGR	Black-grey	1	2.800	6119384
AR45-BF3 AL	Aluminium painted	1	2.800	6119386

PC Polycarbonate

Front locking cover frame for Modul 45 devices, triple, with labelling panel for horizontal device installation, for locking in accessory mounting box 71GD9-2 or in mounting support 71MT3 45-2.

Cover frame AR45, triple, with labelling panel for vertical device installation

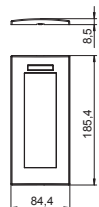

Type

Type	Colour	Pack. Weight		Item No.
		pcs	kg/100 pcs.	
AR45-BSF3 RW	Pure white	1	2.800	6119387
AR45-BSF3 SWGR	Black-grey	1	2.800	6119388
AR45-BSF3 AL	Aluminium painted	1	2.800	6119389

PC Polycarbonate

Front locking cover frame for Modul 45 devices, triple, with labelling panel for vertical device installation, for locking in accessory mounting box 71GD9-2 or in mounting support 71MT3 45-2.

Cover frame AR50, single

Type	Colour	Pack. pcs	Weight kg/100 pcs.	Item No.
AR50-F1 RW	Pure white	1	1.620	6119392
AR50-F1 SWGR	Black-grey	1	1.620	6119394
AR50-F1 AL	Aluminium painted	1	1.620	6119396

PC Polycarbonate

Front locking cover frame for devices with 50 mm central plate, single, without labelling panel for horizontal and vertical device installation, for mounting on accessory mounting box 71GD6, 71GD11 or in mounting support 71MTD.

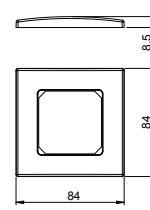

Accessory mounting box for CEE installation 16 A/32 A

Type	Colour	Pack. pcs	Weight kg/100 pcs.	Item No.
71GDCEE	—	1	13.700	6288635

PA Polyamide

Accessory mounting box for installation of a 5-pole CEE socket, 16 A or 32 A, with four-point fastening track 60 x 60 mm or 70 x 70 mm; with external strain relief for jacketed cables of up to Ø 18 mm; with eccentric lock for quick, screwless fastening.

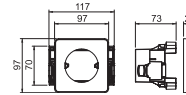

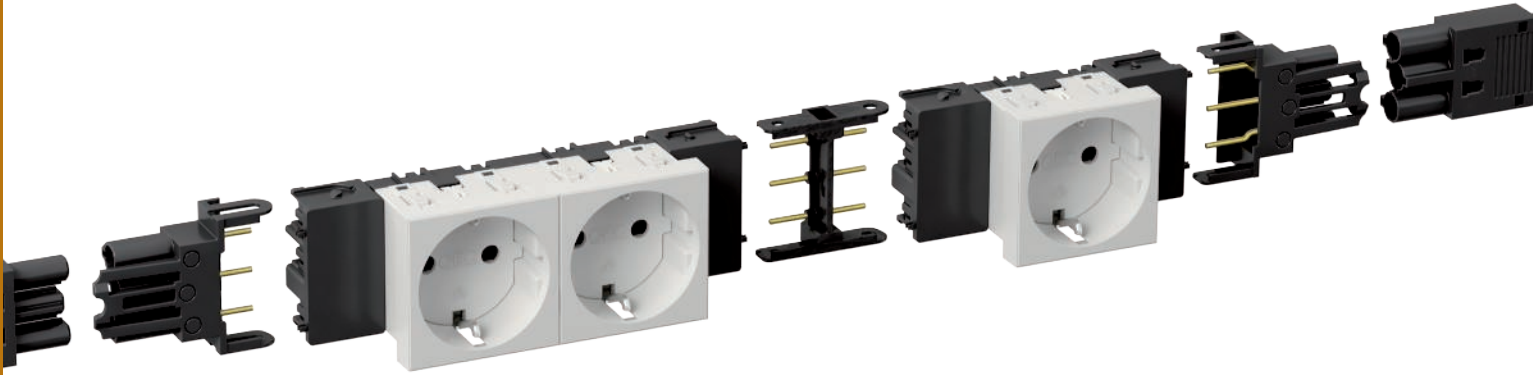







Modul 45connect® – Plug-in installation solutions for device installation ducts and service poles

As continuously connectable installation technology, Modul 45connect for device installation ducts and service poles offers the highest level of flexibility, security and cost efficiency.

From energy distribution through to device connection in the ducts, the system offers all the required installation components.



Modul 45connect® – plug-in installation solutions for device installation trunking and service poles

	Modul 45connect®, sockets for Rapid 45 device installation trunking	68
	Modul 45connect®, sockets for Rapid 80 device installation trunking	69
	Modul 45connect®, 33° sockets for ISS service poles	70
	Modul 45connect®, connection adapter for sockets	71
	Modul 45connect®, cover frame for 80 mm trunking systems	73
	Consolidation Point	74
	Installation accessories for plug connector systems	76

Mounting support, double, for Modul 45®

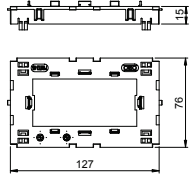

Type

71MT2 45

PA Polyamide

Front locking double mounting support for Modul 45 data technology systems and Modul 45connect protective contact sockets with Wieland connection.

Pack. pcs	Weight		Item No.
	kg/100 pcs.		
5	3.050		6288576

Mounting support, triple, for Modul 45®

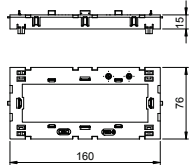

Type

71MT3 45-2

PA Polyamide

Front locking double/triple mounting support for Modul 45 data technology systems and Modul 45connect protective contact sockets with Wieland connection.

Pack. pcs	Weight		Item No.
	kg/100 pcs.		
5	3.200		6288574



Mounting support, double, for Modul 45®

Type	Pack. pcs	Weight kg/100 pcs.	Item No.
71MT2 45	5	3.050	6288576

PA Polyamide

Front locking double mounting support for Modul 45 data technology systems and Modul 45connect protective contact sockets with Wieland connection.

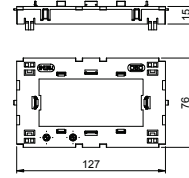

Mounting support, triple, for Modul 45®

Type	Pack. pcs	Weight kg/100 pcs.	Item No.
71MT3 45-2	5	3.200	6288574

PA Polyamide

Front locking double/triple mounting support for Modul 45 data technology systems and Modul 45connect protective contact sockets with Wieland connection.

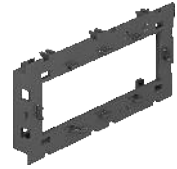
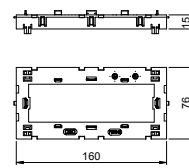

Modul 45connect® connection adapter

Connection adapter, straight, connector part GST18

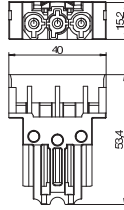

Type	Colour	Pack. Weight		Item No.
		pcs	kg/100 pcs.	
STA-SKS S1 SW	Black	10	1.200	6117192

PA Polyamide

Connector part adapter, straight, for connection to an STD-D0C / STD-D3C or STD-F0C / STD-F3C socket from the side, for VL extension cable with Wieland connector GST 18i 3p.

Connection adapter, straight, socket part GST18

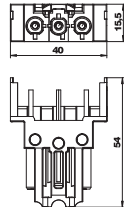

Type	Colour	Pack. Weight		Item No.
		pcs	kg/100 pcs.	
BTA-SKS S1 SW	Black	10	1.200	6117190

PA Polyamide

Connector part adapter, straight, for connection to an STD-D0C / STD-D3C or STD-F0C / STD-F3C socket from the side, for VL extension cable with Wieland connector GST 18i 3p.

Modul 45connect® connector

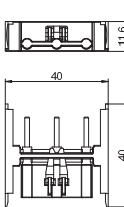

Type	Colour	Pack. Weight		Item No.
		pcs	kg/100 pcs.	
VB-SKS S	Black	10	0.590	6117198

PA Polyamide

Connection adapter for combining STD-D0C / STD-D3C or STD-F0C / STD-F3C sockets.

Connection adapter, GST18i, straight

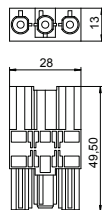

Type	Colour	Pack. Weight		Item No.
		pcs	kg/100 pcs.	
VB-G GST18i3p	Black	10	1.760	6108045

PA Polyamide

Connection adapter GST18i for combining STD-D0C / STD-D3C or STD-F0C / STD-F3C sockets together with straight connection adapters, pluggable connection with integrated strain relief. Suitable for device connections in the device installation trunking systems Rapid 45 and Rapid 80 and in ISS service poles.



Cover frame AR45, single

Type	Colour	Pack. pcs	Weight kg/100 pcs.	Item No.
AR45-F1 RW	Pure white	1	1.600	6119322
AR45-F1 SWGR	Black-grey	1	1.600	6119324
AR45-F1 AL	Aluminium painted	1	1.600	6119326

PC Polycarbonate

Front locking cover frame for Modul 45 devices, single, without labelling panel for horizontal and vertical device installation, for locking in accessory mounting box 71GD8-2.

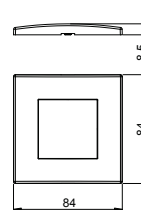
Cover frame AR45, single, with labelling panel for horizontal device installation

Type	Colour	Pack. pcs	Weight kg/100 pcs.	Item No.
AR45-BF1 RW	Pure white	1	1.500	6119332
AR45-BF1 SWGR	Black-grey	1	1.500	6119334
AR45-BF1 AL	Aluminium painted	1	1.500	6119336

PC Polycarbonate

Front locking cover frame for Modul 45 devices, single, with labelling panel for horizontal device installation, for locking in accessory mounting box 71GD8-2.

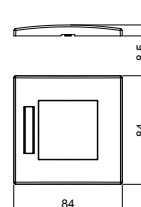
Cover frame AR45, single, with labelling panel for vertical device installation

Type	Colour	Pack. pcs	Weight kg/100 pcs.	Item No.
AR45-BSF1 RW	Pure white	1	1.500	6119338
AR45-BSF1 SWGR	Black-grey	1	1.500	6119339
AR45-BSF1 AL	Aluminium painted	1	1.500	6119340

PC Polycarbonate

Front locking cover frame for Modul 45 devices, single, with labelling panel for vertical device installation, for locking in accessory mounting box 71GD8-2.

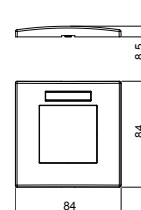
Cover frame AR45, double

Type	Colour	Pack. pcs	Weight kg/100 pcs.	Item No.
AR45-F2 RW	Pure white	1	2.320	6119342
AR45-F2 SWGR	Black-grey	1	2.320	6119344
AR45-F2 AL	Aluminium painted	1	2.320	6119346

PC Polycarbonate

Front locking cover frame for Modul 45 devices, single, without labelling panel for horizontal and vertical device installation, for locking in accessory mounting box 71GD13 or in mounting support 71MT2 45.

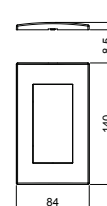
Cover frame AR45, double, with labelling panel for horizontal device installation

Type	Colour	Pack. pcs	Weight kg/100 pcs.	Item No.
AR45-BF2 RW	Pure white	1	2.260	6119352
AR45-BF2 SWGR	Black-grey	1	2.260	6119354
AR45-BF2 AL	Aluminium painted	1	2.260	6119356

PC Polycarbonate

Front locking cover frame for Modul 45 devices, double, with labelling panel for horizontal device installation, for locking in accessory mounting box 71GD13 or in mounting support 71MT2 45.

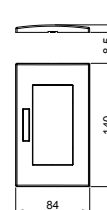

Cover frame AR45, double, with labelling panel for vertical device installation

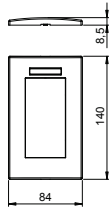

Type	Colour	Pack. pcs	Weight kg/100 pcs.	Item No.
AR45-BSF2 RW	Pure white	1	2.260	6119362
AR45-BSF2 SWGR	Black-grey	1	2.260	6119364
AR45-BSF2 AL	Aluminium painted	1	2.260	6119366

PC Polycarbonate

Front locking cover frame for Modul 45 devices, double, with labelling panel for vertical device installation, for locking in accessory mounting box 71GD13 or in mounting support 71MT2 45.

Cover frame AR45, triple

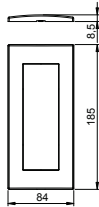

Type	Colour	Pack. pcs	Weight kg/100 pcs.	Item No.
AR45-F3 RW	Pure white	1	2.800	6119372
AR45-F3 SWGR	Black-grey	1	2.800	6119374
AR45-F3 AL	Aluminium painted	1	2.800	6119376

PC Polycarbonate

Front locking cover frame for Modul 45 devices, triple, without labelling panel for horizontal and vertical device installation, for locking in accessory mounting box 71GD9-2 or in mounting support 71MT3 45-2.

Cover frame AR45, triple, with labelling panel for horizontal device installation

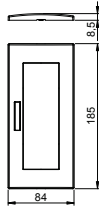

Type	Colour	Pack. pcs	Weight kg/100 pcs.	Item No.
AR45-BF3 RW	Pure white	1	2.800	6119382
AR45-BF3 SWGR	Black-grey	1	2.800	6119384
AR45-BF3 AL	Aluminium painted	1	2.800	6119386

PC Polycarbonate

Front locking cover frame for Modul 45 devices, triple, with labelling panel for horizontal device installation, for locking in accessory mounting box 71GD9-2 or in mounting support 71MT3 45-2.

Cover frame AR45, triple, with labelling panel for vertical device installation

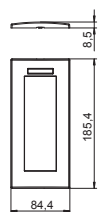

Type	Colour	Pack. pcs	Weight kg/100 pcs.	Item No.
AR45-BSF3 RW	Pure white	1	2.800	6119387
AR45-BSF3 SWGR	Black-grey	1	2.800	6119388
AR45-BSF3 AL	Aluminium painted	1	2.800	6119389

PC Polycarbonate

Front locking cover frame for Modul 45 devices, triple, with labelling panel for vertical device installation, for locking in accessory mounting box 71GD9-2 or in mounting support 71MT3 45-2.



CP support plate for 3 snap-in plug connectors, 3-pole

Type	Pack. pcs	Weight		Item No.
		kg/100	pcs.	
CP45-TP 3SI	1	6.200		6108024

St. Steel

Support plate to accept three snap-In connectors, 3-pole, in a Consolidation Point housing.

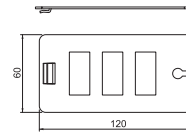

CP support plate for 4 snap-in plug connectors, 3-pole

Type	Pack. pcs	Weight		Item No.
		kg/100	pcs.	
CP45-TP 4SI	1	5.700		6108026

St. Steel

Support plate to accept four snap-In connectors, 3-pole, in a Consolidation Point housing.

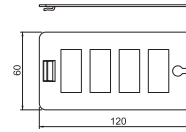

CP support plate, for 8 data connection modules, type C

Type	Pack. pcs	Weight		Item No.
		kg/100	pcs.	
CP45-TP 8C	1	5.400		6108028

St. Steel

Support plate, type C, to accept eight data connection modules in a Consolidation Point housing. Type C has a mounting opening of 19.30 x 14.80 mm.

Support plate type C is suitable for accepting the following data connection modules: BTR (Keystone design): Cat.6A Modul und UAE Modul; Corning: Modules with Keystone seat; CobiNet: CobiDat KS module; Dätwyler: KS-T, KS-TS, MS-K and KU-T; EKU: E-Stone; Harting: Prelink Keystone Cat.6A, Fixlink Keystone Cat.6A; Komos: KDM 500 module; Leoni Kerpen: MegaLine-Connect45 socket modules Keystone; OBO: Data connection modules snap-In type ASM-C5 S, ASM-C5 GS, ASM-C6 S, ASM-C6 GS and Keystone type ASM-C6A, ASM-C6A G; R&M: Cat.6A with Keystone fastening; Rutenbeck: UM and UMflex; SETEC: UKJ and XKJ; Telegärtner: AMJ and UMJ.

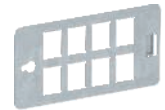
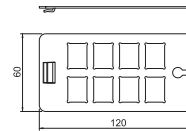

Connection cables with GST18 connector system

3-wire connection cable, PVC, cross-section 1.5 mm², black

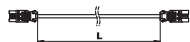

Type	Cable length mm	Cross-section mm ²	Number of poles	Colour	Pack. pcs	Weight kg/100 pcs.	Item No.
VL-3Q1.5 1 SW	1000	—	3	Black	1	14.000	6108100
VL-3Q1.5 2 SW	2000	—	3	Black	1	28.000	6108101
VL-3Q1.5 3 SW	3000	—	3	Black	1	42.000	6108102
VL-3Q1.5 4 SW	4000	—	3	Black	1	56.000	6108103
VL-3Q1.5 5 SW	5000	—	3	Black	1	70.000	6108104
VL-3Q1.5 6 SW	6000	—	3	Black	1	84.000	6108105
VL-3Q1.5 7 SW	7000	—	3	Black	1	98.000	6108106
VL-3Q1.5 8 SW	8000	—	3	Black	1	112.000	6108107
VL-3Q1.5 9 SW	9000	—	3	Black	1	126.000	6108108
VL-3Q1.5 10 SW	10000	—	3	Black	1	140.000	6108109

Connection cable 3 x 1.5 mm² in the version socket – connector with GST18i connection system.

3-wire connection cable, PVC, cross-section 1.5 mm², white



Type	Cable length mm	Cross-section mm ²	Number of poles	Colour	Pack. pcs	Weight kg/100 pcs.	Item No.
VL-3Q1.5 1 W	1000	—	3	White	1	14.000	6108125
VL-3Q1.5 2 W	2000	—	3	White	1	28.000	6108126
VL-3Q1.5 3 W	3000	—	3	White	1	42.000	6108127
VL-3Q1.5 4 W	4000	—	3	White	1	56.000	6108128
VL-3Q1.5 5 W	5000	—	3	White	1	70.000	6108129
VL-3Q1.5 6 W	6000	—	3	White	1	84.000	6108130
VL-3Q1.5 7 W	7000	—	3	White	1	98.000	6108131
VL-3Q1.5 8 W	8000	—	3	White	1	112.000	6108132
VL-3Q1.5 9 W	9000	—	3	White	1	126.000	6108133
VL-3Q1.5 10 W	10000	—	3	White	1	140.000	6108134

Connection cable 3 x 1.5 mm² in the version socket – connector with GST18i connection system.

3-wire connection cable, PVC, cross-section 2.5 mm², black

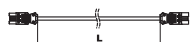

Type	Cable length mm	Cross-section mm ²	Number of poles	Colour	Pack. pcs	Weight kg/100 pcs.	Item No.
VL-3Q2.5 1 SW	1000	2.5	3	Black	1	18.000	6108150
VL-3Q2.5 2 SW	2000	2.5	3	Black	1	36.000	6108151
VL-3Q2.5 3 SW	3000	2.5	3	Black	1	54.000	6108152
VL-3Q2.5 4 SW	4000	2.5	3	Black	1	72.000	6108153
VL-3Q2.5 5 SW	5000	2.5	3	Black	1	90.000	6108154
VL-3Q2.5 6 SW	6000	2.5	3	Black	1	108.000	6108155
VL-3Q2.5 7 SW	7000	2.5	3	Black	1	126.000	6108156
VL-3Q2.5 8 SW	8000	2.5	3	Black	1	144.000	6108157
VL-3Q2.5 9 SW	9000	2.5	3	Black	1	162.000	6108158
VL-3Q2.5 10 SW	10000	2.5	3	Black	1	180.000	6108159

Connection cable 3 x 2.5 mm² in the version socket – connector with GST18i connection system.

3-wire connection cable, PVC, cross-section 2.5 mm², white



Type	Cable length mm	Cross-section mm ²	Number of poles	Colour	Pack. pcs	Weight kg/100 pcs.	Item No.
VL-3Q2.5 1 W	1000	2.5	3	White	1	18.000	6108175
VL-3Q2.5 2 W	2000	2.5	3	White	1	36.000	6108176
VL-3Q2.5 3 W	3000	2.5	3	White	1	54.000	6108177
VL-3Q2.5 4 W	4000	2.5	3	White	1	72.000	6108178
VL-3Q2.5 5 W	5000	2.5	3	White	1	90.000	6108179
VL-3Q2.5 6 W	6000	2.5	3	White	1	108.000	6108180
VL-3Q2.5 7 W	7000	2.5	3	White	1	126.000	6108181
VL-3Q2.5 8 W	8000	2.5	3	White	1	144.000	6108182
VL-3Q2.5 9 W	9000	2.5	3	White	1	162.000	6108183
VL-3Q2.5 10 W	10000	2.5	3	White	1	180.000	6108184

Connection cable 3 x 2.5 mm² in the version socket – connector with GST18i connection system.

3-wire connection cable, halogen-free, cross-section 2.5 mm², black

Type	Cable length mm	Cross-section mm ²	Number of poles	Colour	Pack. pcs	Weight kg/100 pcs.	Item No.
VL-3Q2.5 H1 SW	1000	2.5	3	Black	1	16.000	6108450
VL-3Q2.5 H2 SW	2000	2.5	3	Black	1	32.000	6108451
VL-3Q2.5 H3 SW	3000	2.5	3	Black	1	48.000	6108452
VL-3Q2.5 H4 SW	4000	2.5	3	Black	1	64.000	6108453
VL-3Q2.5 H5 SW	5000	2.5	3	Black	1	80.000	6108454
VL-3Q2.5 H6 SW	6000	2.5	3	Black	1	96.000	6108455
VL-3Q2.5 H7 SW	7000	2.5	3	Black	1	112.000	6108456
VL-3Q2.5 H8 SW	8000	2.5	3	Black	1	128.000	6108457
VL-3Q2.5 H9 SW	9000	2.5	3	Black	1	144.000	6108458
VL-3Q2.5 H10 SW	10000	2.5	3	Black	1	160.000	6108459

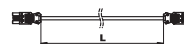

Halogen-free connection cables 3 x 2.5 mm² in the version socket – connector with GST18i connection system.

3-wire connection cable, halogen-free, cross-section 2.5 mm², white

Type	Cable length mm	Cross-section mm ²	Number of poles	Colour	Pack. pcs	Weight kg/100 pcs.	Item No.
VL-3Q2.5 H1 W	1000	2.5	3	White	1	16.000	6108475
VL-3Q2.5 H2 W	2000	2.5	3	White	1	32.000	6108476
VL-3Q2.5 H3 W	3000	2.5	3	White	1	48.000	6108477
VL-3Q2.5 H4 W	4000	2.5	3	White	1	64.000	6108478
VL-3Q2.5 H5 W	5000	2.5	3	White	1	80.000	6108479
VL-3Q2.5 H6 W	6000	2.5	3	White	1	96.000	6108480
VL-3Q2.5 H7 W	7000	2.5	3	White	1	112.000	6108481
VL-3Q2.5 H8 W	8000	2.5	3	White	1	128.000	6108482
VL-3Q2.5 H9 W	9000	2.5	3	White	1	144.000	6108483
VL-3Q2.5 H10 W	10000	2.5	3	White	1	160.000	6108484

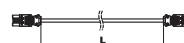

Halogen-free connection cables 3 x 2.5 mm² in the version socket – connector with GST18i connection system.



Connector part 3-pin, spring power connection

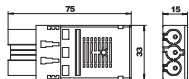

Type	Colour	Pack.	Weight	Item No.
		pcs	kg/100 pcs.	
ST-F GST18i3p SW	Black	1	2.600	6108050
ST-F GST18i3p W	White	1	2.620	6108051

Connector part, 3-pin, type GST18i with spring power connection for rigid cables of 1.5–2.5 mm², single-wire and ultrasonically welded, fine wire cables 1.5 mm² with end sleeves, unmounted with strain relief, can be terminated in situ, 250 V, 16 A.

Two connections per pole, for cables H05VV, NYM (Ø 7.8–10.33 mm), lockable, a lock should be provided for strain relief according to VDE 0628.

Stripping length: 45 mm
Stripped length: 9 mm

Connector part, 3-pin, screw connection

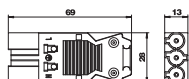

Type	Colour	Pack.	Weight	Item No.
		pcs	kg/100 pcs.	
ST-S GST18i3p SW	Black	1	2.030	6108054
ST-S GST18i3p W	White	1	2.030	6108055

Connector part, 3-pin, type GST18i with screw connection, low height (no slot loss in combination with distributor blocks), for cross-sections of 0.75–2.5 mm², single- and fine-wire cables connectable without end sleeve, for cable diameters between 6.5–10.5 mm (H05VV, NYM), unmounted with strain relief, terminable in situ, 250 V, 16 A.

Stripping length: 31 mm
Insulation removal length: 7 mm

Socket section 3-pin, spring power connection

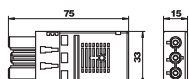

Type	Colour	Pack.	Weight	Item No.
		pcs	kg/100 pcs.	
BT-F GST18i3p SW	Black	1	2.620	6108052
BT-F GST18i3p W	White	1	2.690	6108053

Socket part, 3-pin, type GST18i with spring power connection for rigid cables of 1.5–2.5 mm², single-wire and ultrasonically welded, fine wire cables 1.5 mm² with end sleeves, unmounted with strain relief, can be terminated in situ, 250 V, 16 A.

Two connections per pole, for cables H05VV, NYM (Ø 7.8–10.33 mm), lockable, a lock should be provided for strain relief according to VDE 0628.

Stripping length: 45 mm
Stripped length: 9 mm

Socket section 3-pin, screw connection

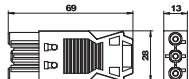

Type	Colour	Pack.	Weight	Item No.
		pcs	kg/100 pcs.	
BT-S GST18i3p SW	Black	1	2.150	6108056
BT-S GST18i3p W	White	1	2.150	6108057

Socket part, 3-pin, type GST18i with screw connection, low height (no slot loss in combination with distributor blocks), for cross-sections of 0.75–2.5 mm², single- and fine-wire cables connectable without end sleeve, for cable diameters between 6.5–10.5 mm (H05VV, NYM), unmounted with strain relief, terminable in situ, 250 V, 16 A.

Stripping length: 31 mm
Insulation removal length: 7 mm

Distributor block 3-pin

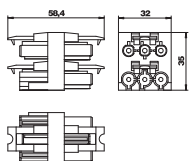

Type	Colour	Pack.	Weight	Item No.
		pcs	kg/100 pcs.	
VB-3 GST18i3p	Black	1	3.590	6108080

Distributor block with lock, type GST18i, one input with plug section 3-pin and three outputs with socket section 3-pin.

Distributor block 3-pin

Type	Colour	Pack. pcs	Weight kg/100 pcs.	Item No.
VB-5 GST18i3p	Black	1	5.590	6108082

Distributor block with lock, type GST18i, one input with plug section 3-pin and five outputs with socket section 3-pin.

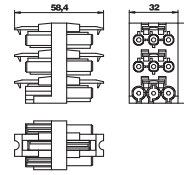

Distributor block, 3-pin, T-shaped

Type	Colour	Pack. pcs	Weight kg/100 pcs.	Item No.
VB-T GST18i3p	Black	1	2.540	6108084

T distributor with lock, type GST18i, one input with 3-pin connector part and two outputs with 3-pin socket part.

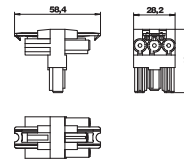

Connector part, 5-pin, screw connection

Type	Colour	Pack. pcs	Weight kg/100 pcs.	Item No.
ST-S GST18i5p SW	Black	1	4.330	6108070

Connector part, 5-pin, type GST18i, with screw connection for 1.5–2.5 mm² cables, single and fine-wire, with strain relief, one connection per pin, unmounted, for cables H05VV (Ø 9.5–13.5) NYM and (Ø 10.5–13.5 mm), lockable, according to the strain relief in VDE 0628 a lock should be planned, 250 V, 16 A.

Stripping length: 8 mm
Jacket removal length: 46 mm

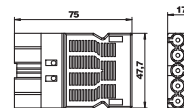

Socket section 5-pin, screw connection

Type	Colour	Pack. pcs	Weight kg/100 pcs.	Item No.
BT-S GST18i5p SW	Black	1	4.550	6108072

Socket part, 5-pin, type GST18i, with screw connection for 1.5 to 2.5 mm² cables, single and fine-wire, with strain relief, one connection per pin, unmounted, for cables H05VV (Ø 9.5 – 13.5) NYM and (Ø 10.5 to 13.5 mm), lockable, according to the strain relief in VDE 0628 a lock should be planned, 250 V, 16 A.

Stripping length: 8 mm
Jacket removal length: 46 mm

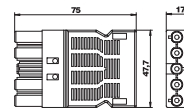

Distributor block, 3-pole

Type	Colour	Pack. pcs	Weight kg/100 pcs.	Item No.
VB-2 GST18i3p	Black	1	3.300	6108086

PA Polyamide

Distributor block with lock, type GST18i, 1 input with 3-pin plug section and 2 outputs with 3-pin socket section.

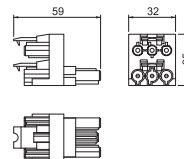

Connector part, 3-pin, screw connection

Type	Colour	Pack. pcs	Weight kg/100 pcs.	Item No.
ST-S4 GST18i3 SW	Black	1	1.600	6108060
ST-S4 GST18i3 W	White	1	1.600	6108062

PA Polyamide

Connector part, 3-pin, type GST18i with screw connection for cables of 1.5–4.0 mm² and cable diameters between 10.5–14.5 mm (H05VV, NYM), unmounted with strain relief, terminable in situ, 250 V, 16 A.

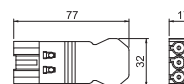

Socket section 3-pin, screw connection

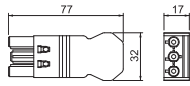

Type	Colour	Pack. Weight		Item No.
		pcs	kg/100 pcs.	
BT-S4 GST18i3 SW	Black	1	1.600	6108064
BT-S4 GST18i3 W	White	1	1.600	6108066

PA Polyamide

Socket section, 3-pin, type GST18i with screw connection for cables of 1.5–4.0 mm² and for cable diameters between 10.5–14.5 mm (H05VV, NYM), unmounted with strain relief, terminable in situ, 250 V, 16 A.

Locking

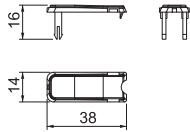

Type	Colour	Pack. Weight		Item No.
		pcs	kg/100 pcs.	
VR-GST18	Black	10	0.100	6108074

PA Polyamide

Locking clip for GST18, plug connections, for locking connection cables.



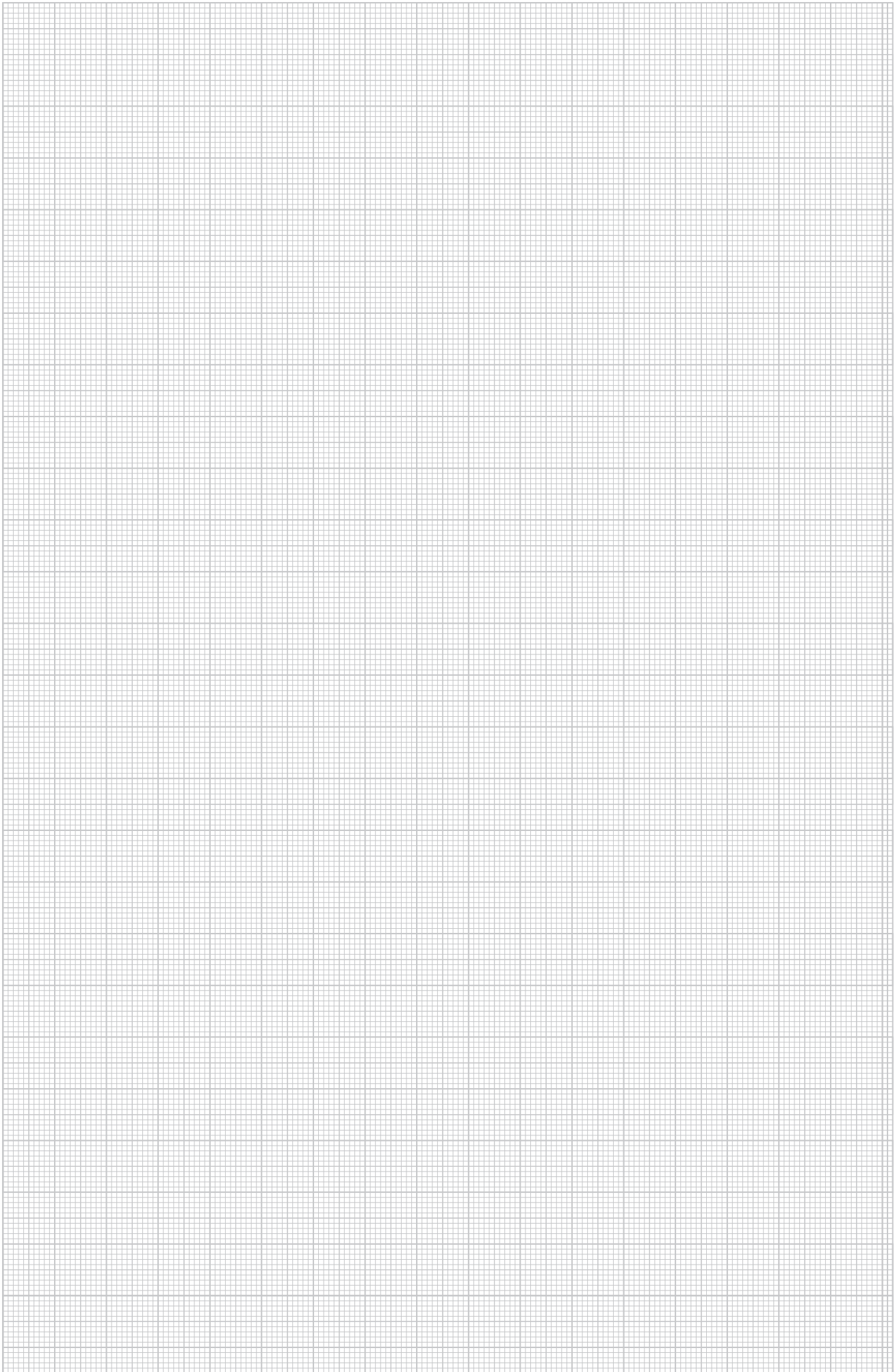





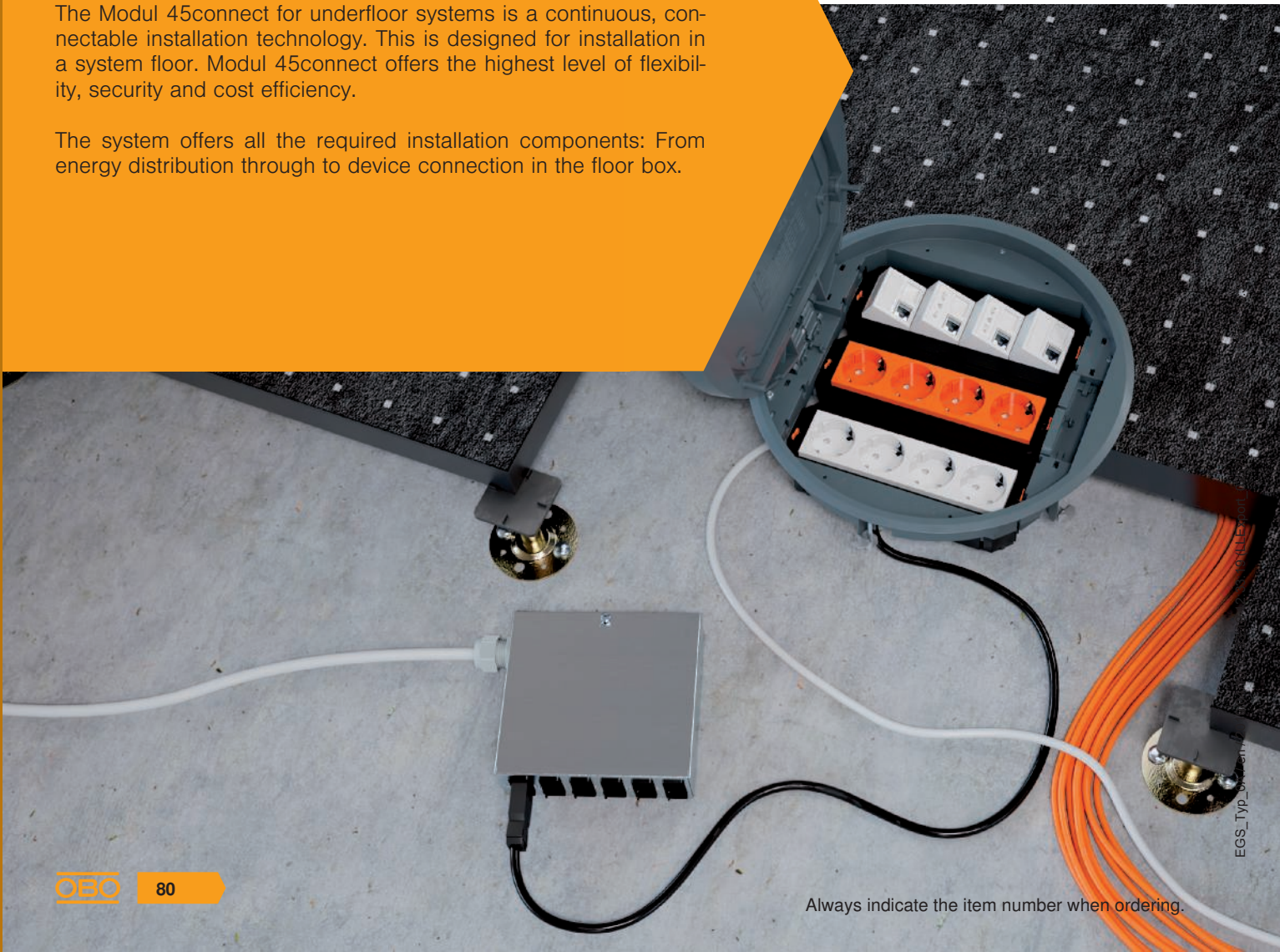

Modul 45connect® – plug-in installation solutions for raised and cavity floors

The Modul 45connect for underfloor systems is a continuous, connectable installation technology. This is designed for installation in a system floor. Modul 45connect offers the highest level of flexibility, security and cost efficiency.

The system offers all the required installation components: From energy distribution through to device connection in the floor box.



Modul 45connect® – plug-in device installation solutions for raised and cavity floors

	Modul 45connect®, ready-for-connection universal support UTC	82
	Modul 45connect®, sockets and UT universal support	85
	Energy distributor and Consolidation Point	89
	Installation accessories for plug connector systems	94

UTC3 with 2 protective contact sockets

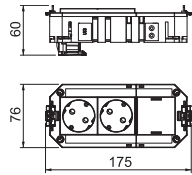

Type	Connection		Pack. pcs	Weight kg/100 pcs.	Item No.
	Circuit	system			
UTC3 G W2	1	GST18	1	16.370	7404662

The ready-for-connection UTC3 universal support possesses two pre-installed 33° protective contact sockets and one blanking cover for reinstallation of one installation device of the Modul 45 or Modul 45connect series.

UTC3 with 3 protective contact sockets

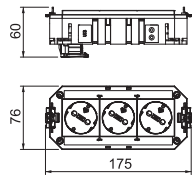

Type	Connection		Pack. pcs	Weight kg/100 pcs.	Item No.
	Circuit	system			
UTC3 G W3	1	GST18	1	19.780	7404664

The ready-for-connection UTC3 universal support possesses three pre-installed 33° protective contact sockets with 16 A.

UTC3 with 2+1 protective contact sockets

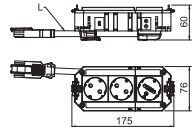

Type	Connection		Pack. pcs	Weight kg/100 pcs.	Item No.
	Circuit	system			
UTC3 G W2OR1	2	GST18	1	26.630	7404660

Ready-for-connection UTC3 universal support with halogen-free connection cable. It possesses two pre-installed 33° protective contact sockets in white and one pre-installed 33° protective contact socket in orange with 16 A.



UTC4 with 2 protective contact sockets



Type	Connection			Pack. pcs	Weight kg/100 pcs.	Item No.
	Circuit	system	Version			
UTC4 G W2	1	GST18	Double pure white	1	18.500	7404674
UTC4 G OR2	1	GST18	Double pure orange	1	18.460	7404670

The ready-for-connection UTC4 universal support possesses two pre-installed 33° protective contact sockets with 16 A and two blanking covers for reinstallation of two installation devices of the Modul 45 or Modul 45connect series.

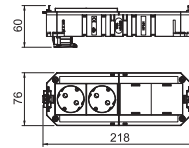

UTC4 with 3 protective contact sockets



Type	Connection			Pack. pcs	Weight kg/100 pcs.	Item No.
	Circuit	system	Version			
UTC4 G W3	1	GST18	Triple pure white	1	21.960	7404680

The ready-for-connection UTC4 universal support possesses three pre-installed 33° protective contact sockets with 16 A and one blanking cover for reinstallation of one installation device of the Modul 45 or Modul 45connect series.

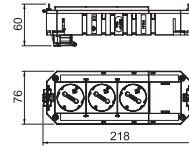

UTC4 with 4 protective contact sockets



Type	Connection			Pack. pcs	Weight kg/100 pcs.	Item No.
	Circuit	system	Version			
UTC4 G W4	1	GST18	4x pure white	1	26.830	7404682
UTC4 G OR4	1	GST18	4x pure orange	1	26.730	7404672

The ready-for-connection UTC4 universal support possesses four pre-installed 33° protective contact sockets with 16 A.

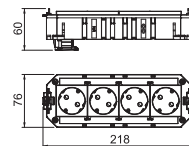

UTC4 with 2+2 protective contact sockets



Type	Connection			Pack. pcs	Weight kg/100 pcs.	Item No.
	Circuit	system	Version			
UTC4 G W2OR2	2	GST18	Double pure white/ Double pure orange	1	27.290	7404676

The ready-for-connection UTC4 universal support possesses two pre-installed 33° protective contact sockets in pure white and two 33° pre-installed protective contact sockets in pure orange with 16 A.

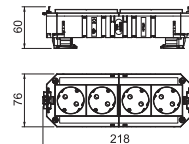

UTC4 with 2+2 protective contact sockets, 2 sockets with surge protection



Type	Connection			Pack. pcs	Weight kg/100 pcs.	Item No.
	Circuit	system	Version			
UTC4 G W2OR2 Ü	2	GST18	Double pure white/ Double pure orange	1	31.300	7404678

The ready-for-connection UTC4 universal support possesses two pre-installed 33° protective contact sockets in pure white and two pre-installed 33° protective contact sockets in pure orange with 16 A. The protective contact sockets in pure orange are protected by a type 3 surge protection module according to DIN EN 61643-11.

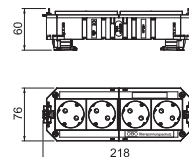

UTC4 with 3+1 protective contact sockets

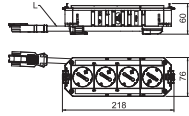

Type	Connection		Version	Pack. pcs	Weight kg/100 pcs.	Item No.
	Circuit	system				
UTC4 G W3OR1	2	GST18	Triple pure white/ Single pure orange	1	29.510	7404684

Ready-for-connection universal support UTC4 with halogen-free connection cable. It possesses three pre-installed 33° protective contact sockets in pure white and one 33° protective contact socket in pure orange with 16 A.

UTC4 with 3+1 protective contact sockets, 1 socket with surge protection

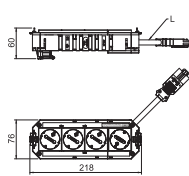

Type	Connection		Version	Pack. pcs	Weight kg/100 pcs.	Item No.
	Circuit	system				
UTC4 G W3OR1 Ü	2	GST18	Triple pure white/ Single pure orange	1	33.530	7404686

Ready-for-connection universal support UTC4 with halogen-free connection cable. It possesses three pre-installed 33° protective contact sockets in white and one 33° protective contact socket in pure orange with 16 A. The protective contact socket in pure orange is protected by a type 3 surge protection module according to DIN EN 61643-11.

UTC4 with 2+1 protective contact sockets

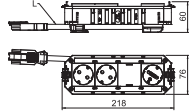

Type	Connection		Version	Pack. pcs	Weight kg/100 pcs.	Item No.
	Circuit	system				
UTC4 G OR2GN1	2	GST18	Double pure orange / Single mint green	1	32.200	7404688

Ready-for-connection universal support UTC4 with halogen-free connection cable. It possesses two pre-installed 33° protective contact sockets in orange and one 33° protective contact socket in mint green with 16 A. A blanking cover allows retroinstallation of one installation device of the Modul 45 or Modul 45connect series.



Universal support UT3, system length 165 mm

Type	Length	Installation	Width	Height	Pack.	Weight	Item No.
	mm	technology	mm	mm		pcs	
UT3 45 3	165	Grid M45	76	40	1	10.600	7408723

PA Polyamide

Universal support with two strain reliefs, mounting bridge, partition and UT3 P3 cover plate for installation of 3 Modul 45 devices in device installation units of nominal sizes 2, R4, 4, 6 and R7.

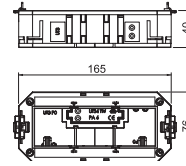

Universal support UT4, system length 208 mm

Type	Length	Width	Height	Pack.	Weight	Item No.
	mm	mm	mm		pcs	
UT4 45 4	208	76	40	1	13.500	7408727

PA Polyamide

Universal support with two strain reliefs, mounting bridges, partition and UT4 P4 cover plate for installation of 4 Modul 45 devices in device installation units of nominal sizes R7, R9 and 9.

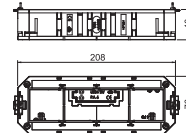

Universal support UT3, system length 165 mm

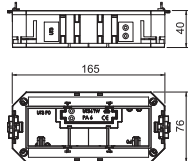

Type	Length	Installation	Width	Height	Pack.	Weight	Item No.
	mm	technology	mm	mm	pcs	kg/100 pcs.	
UT3 45 3	165	Grid M45	76	40	1	10.600	7408723

PA Polyamide

Universal support with two strain reliefs, mounting bridge, partition and UT3 P3 cover plate for installation of 3 Modul 45 devices in device installation units of nominal sizes 2, R4, 4, 6 and R7.

Universal support UT4, system length 208 mm

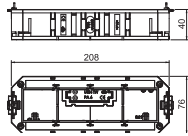

Type	Length	Width	Height	Pack.	Weight	Item No.
	mm	mm	mm	pcs	kg/100 pcs.	
UT4 45 4	208	76	40	1	13.500	7408727

PA Polyamide

Universal support with two strain reliefs, mounting bridges, partition and UT4 P4 cover plate for installation of 4 Modul 45 devices in device installation units of nominal sizes R7, R9 and 9.



Modul 45connect® connector part adapter

Type	Colour	Pack. pcs	Weight kg/100 pcs.	Item No.
STA-SKS SU1 W	White	10	1.190	6117197

PA Polyamide

Connector part adapter, U-shaped, for connection to an STD-D0C / STD-D3C or STD-F0C / STD-F3C socket from the side, for VL extension cable with Wieland connector GST 18i 3p.

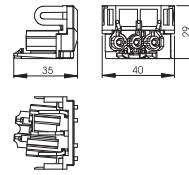

Modul 45connect® connector

Type	Colour	Pack. pcs	Weight kg/100 pcs.	Item No.

PA Polyamide

Connection adapter for combining STD-D0C / STD-D3C or STD-F0C / STD-F3C sockets.

Note: Socket combinations with two connection adapters at most are permitted.

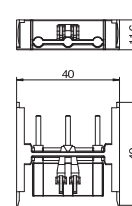

CP support plate for 3 snap-in plug connectors, 3-pole

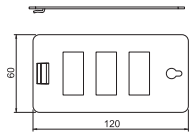

Type

CP45-TP 3SI

SI Steel

Support plate to accept three snap-In connectors, 3-pole, in a Consolidation Point housing.

Pack. pcs	Weight		Item No.
	kg/100 pcs.		
1	6.200		6108024

CP support plate for 4 snap-in plug connectors, 3-pole

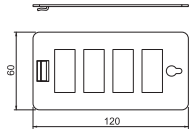
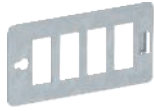

Type

CP45-TP 4SI

SI Steel

Support plate to accept four snap-In connectors, 3-pole, in a Consolidation Point housing.

Pack. pcs	Weight		Item No.
	kg/100 pcs.		
1	5.700		6108026

CP support plate, for 8 data connection modules, type C

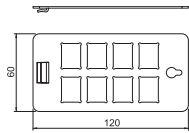
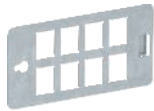

Type

CP45-TP 8C

SI Steel

Support plate, type C, to accept eight data connection modules in a Consolidation Point housing. Type C has a mounting opening of 19.30 x 14.80 mm.

Support plate type C is suitable for accepting the following data connection modules: BTR (Keystone design): Cat.6A Modul und UAE Modul; Corning: Modules with Keystone seat; CobiNet: CobiDat KS module; Dätwyler: KS-T, KS-TS, MS-K and KU-T; EKU: E-Stone; Harting: Prelink Keystone Cat.6A, Fixlink Keystone Cat.6A; Komos: KDM 500 module; Leoni Kerpen: MegaLine-Connect45 socket modules Keystone; OBO: Data connection modules snap-In type ASM-C5 S, ASM-C5 GS, ASM-C6 S, ASM-C6 GS and Keystone type ASM-C6A, ASM-C6A G; R&M: Cat.6A with Keystone fastening; Rutenbeck: UM and UMflex; SETEC: UKJ and XKJ; Telegärtner: AMJ and UMJ.

Pack. pcs	Weight		Item No.
	kg/100 pcs.		
1	5.400		6108028



UVS energy distributor with fixed connection, normal circuit

Type	Pack. pcs	Weight		Item No.
		kg/100	pcs.	
UVS-6S2	1	77.000		6108000

St Steel

Energy distributor for heavy current technology with fixed connection, equipped and pre-wired.

Input: One 3-phase circuit via a screwless terminal block, 5-pin, for cable cross-sections of 0.5–4 mm².

Output: Six self-locking connectors, 3-pin, in black, 16 A, type GST18i (socket part: 2 x L1, 2 x L2, 2 x L3).

Internal wiring: PVC non-sheathed cable H07V-U2.5.

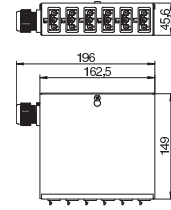

UVS energy distributor with fixed connection, special circuit

Type	Pack. pcs	Weight		Item No.
		kg/100	pcs.	
UVS-6W2	1	77.000		6108005

St Steel

Energy distributor for heavy current technology with fixed connection, equipped and pre-wired.

Input: One 3-phase circuit via a screwless terminal block, 5-pin, for cable cross-sections of 0.5–4 mm².

Output: Six self-locking connectors, 3-pin, in white, 16 A, type GST18i (socket part: 2 x L1, 2 x L2, 2 x L3).

Internal wiring: PVC non-sheathed cable H07V-U2.5.

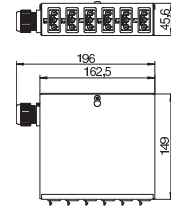

UVS energy distributor with fixed connection, normal and special circuit

Type	Pack. pcs	Weight		Item No.
		kg/100	pcs.	
UVS-6S6W2	1	146.100		6108010

St Steel

Energy distributor for heavy current technology with fixed connection, equipped and pre-wired.

Input: Two 3-phase circuits via a screwless terminal block, 5-pin, for cable cross-sections of 0.5–4 mm².

Output: Twelve self-locking connectors, 3-pin, in white (6x) and black (6x), 16 A, type GST18i (socket part: 2 x L1, 2 x L2, 2 x L3 for each rotary current circuit).

Internal wiring: PVC non-sheathed cable H07V-U2.5.

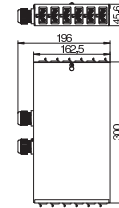

UVS energy distributor with plug connection, normal circuit

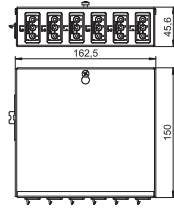

Type

UVS-6S2SA

St Steel

Energy distributor for heavy current technology with plug connection, equipped and pre-wired.

Input: One 3-phase circuit using a self-locking connector, 5-pin, type GST18i (connector part).
Output: Six self-locking connectors, 3-pin, in black, 16 A, type GST18i (socket part: 2 x L1, 2 x L2, 2 x L3).

Internal wiring: PVC non-sheathed cable H07V-U2.5.

Pack. pcs	Weight		Item No.
	kg/100 pcs.	pcs.	
1	79.000		6108012

UVS energy distributor with plug connection, special circuit

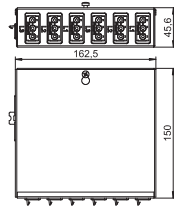

Type

UVS-6W2SA

St Steel

Energy distributor for heavy current technology with plug connection, equipped and pre-wired.

Input: One 3-phase circuit using a self-locking connector, 5-pin, type GST18i (connector part).
Output: Six self-locking connectors, 3-pin, in white, 16 A, type GST18i (socket part: 2 x L1, 2 x L2, 2 x L3).

Internal wiring: PVC non-sheathed cable H07V-U2.5.

Pack. pcs	Weight		Item No.
	kg/100 pcs.	pcs.	
1	79.000		6108014

UVS energy distributor with plug connection, normal and special circuit



Type

UVS-6S6W2SA

St Steel

Energy distributor for heavy current technology with plug connection, equipped and pre-wired.

Input: Two 3-phase circuits using self-locking connectors, 5-pin, type GST18i (connector part).
Output: Twelve self-locking connectors, 3-pin, in white (6x) and black (6x), 16 A, type GST18i (socket part: 2 x L1, 2 x L2, 2 x L3 for each rotary current circuit).

Internal wiring: PVC non-sheathed cable H07V-U2.5.

Pack. pcs	Weight		Item No.
	kg/100 pcs.	pcs.	
1	140.000		6108016



UVS energy distributor with fixed connection, normal circuit

Type	Colour	Pack. pcs	Weight kg/100 pcs.	Item No.

- St Steel
- FS Strip-galvanised

Energy distributor for heavy current technology with plug connection, equipped and pre-wired.
 Input: one single-phase circuit using a self-locking connector, 3-pin, Type GST18i (connector part).
 Output: Six self-locking connectors, 3-pin, in black, 16 A, Type GST18i
 Internal wiring: PVC non-sheathed cable H07V-U2.5.

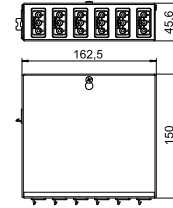

UVS energy distributor with fixed connection, special circuit

Type	Colour	Pack. pcs	Weight kg/100 pcs.	Item No.

- St Steel
- FS Strip-galvanised

Energy distributor for heavy current technology with plug connection, equipped and pre-wired.
 Input: one single-phase circuit using a self-locking connector, 3-pin, Type GST18i (connector part).
 Output: Six self-locking connectors, 3-pin, in white, 16 A, Type GST18i
 Internal wiring: PVC non-sheathed cable H07V-U2.5.

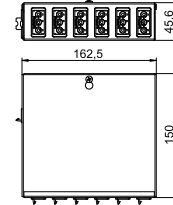

Connection cables with GST18 connector system

3-wire connection cable, PVC, cross-section 1.5 mm², black

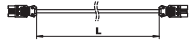

Type	Cable length mm	Cross-section mm ²	Number of poles	Colour	Pack. pcs	Weight kg/100 pcs.	Item No.
VL-3Q1.5 1 SW	1000	—	3	Black	1	14.000	6108100
VL-3Q1.5 2 SW	2000	—	3	Black	1	28.000	6108101
VL-3Q1.5 3 SW	3000	—	3	Black	1	42.000	6108102
VL-3Q1.5 4 SW	4000	—	3	Black	1	56.000	6108103
VL-3Q1.5 5 SW	5000	—	3	Black	1	70.000	6108104
VL-3Q1.5 6 SW	6000	—	3	Black	1	84.000	6108105
VL-3Q1.5 7 SW	7000	—	3	Black	1	98.000	6108106
VL-3Q1.5 8 SW	8000	—	3	Black	1	112.000	6108107
VL-3Q1.5 9 SW	9000	—	3	Black	1	126.000	6108108
VL-3Q1.5 10 SW	10000	—	3	Black	1	140.000	6108109

Connection cable 3 x 1.5 mm² in the version socket – connector with GST18i connection system.

3-wire connection cable, PVC, cross-section 1.5 mm², white

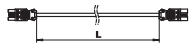

Type	Cable length mm	Cross-section mm ²	Number of poles	Colour	Pack. pcs	Weight kg/100 pcs.	Item No.
VL-3Q1.5 1 W	1000	—	3	White	1	14.000	6108125
VL-3Q1.5 2 W	2000	—	3	White	1	28.000	6108126
VL-3Q1.5 3 W	3000	—	3	White	1	42.000	6108127
VL-3Q1.5 4 W	4000	—	3	White	1	56.000	6108128
VL-3Q1.5 5 W	5000	—	3	White	1	70.000	6108129
VL-3Q1.5 6 W	6000	—	3	White	1	84.000	6108130
VL-3Q1.5 7 W	7000	—	3	White	1	98.000	6108131
VL-3Q1.5 8 W	8000	—	3	White	1	112.000	6108132
VL-3Q1.5 9 W	9000	—	3	White	1	126.000	6108133
VL-3Q1.5 10 W	10000	—	3	White	1	140.000	6108134

Connection cable 3 x 1.5 mm² in the version socket – connector with GST18i connection system.

3-wire connection cable, halogen-free, cross-section 2.5 mm², white



Type	Cable length mm	Cross-section mm ²	Number of poles	Colour	Pack. pcs	Weight kg/100 pcs.	Item No.
VL-3Q2.5 H1 W	1000	2.5	3	White	1	16.000	6108475
VL-3Q2.5 H2 W	2000	2.5	3	White	1	32.000	6108476
VL-3Q2.5 H3 W	3000	2.5	3	White	1	48.000	6108477
VL-3Q2.5 H4 W	4000	2.5	3	White	1	64.000	6108478
VL-3Q2.5 H5 W	5000	2.5	3	White	1	80.000	6108479
VL-3Q2.5 H6 W	6000	2.5	3	White	1	96.000	6108480
VL-3Q2.5 H7 W	7000	2.5	3	White	1	112.000	6108481
VL-3Q2.5 H8 W	8000	2.5	3	White	1	128.000	6108482
VL-3Q2.5 H9 W	9000	2.5	3	White	1	144.000	6108483
VL-3Q2.5 H10 W	10000	2.5	3	White	1	160.000	6108484

Halogen-free connection cables 3 x 2.5 mm² in the version socket – connector with GST18i connection system.

3-wire connection cable, halogen-free, cross-section 2.5 mm², black

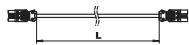

Type	Cable length mm	Cross-section mm ²	Number of poles	Colour	Pack. pcs	Weight kg/100 pcs.	Item No.
VL-3Q2.5 H1 SW	1000	2.5	3	Black	1	16.000	6108450
VL-3Q2.5 H2 SW	2000	2.5	3	Black	1	32.000	6108451
VL-3Q2.5 H3 SW	3000	2.5	3	Black	1	48.000	6108452
VL-3Q2.5 H4 SW	4000	2.5	3	Black	1	64.000	6108453
VL-3Q2.5 H5 SW	5000	2.5	3	Black	1	80.000	6108454
VL-3Q2.5 H6 SW	6000	2.5	3	Black	1	96.000	6108455
VL-3Q2.5 H7 SW	7000	2.5	3	Black	1	112.000	6108456
VL-3Q2.5 H8 SW	8000	2.5	3	Black	1	128.000	6108457
VL-3Q2.5 H9 SW	9000	2.5	3	Black	1	144.000	6108458
VL-3Q2.5 H10 SW	10000	2.5	3	Black	1	160.000	6108459

Halogen-free connection cables 3 x 2.5 mm² in the version socket – connector with GST18i connection system.



3-wire connection cable, PVC, cross-section 2.5 mm², white

Type	Cable length mm	Cross-section mm ²	Number of poles	Colour	Pack. pcs	Weight kg/100 pcs.	Item No.
VL-3Q2.5 1 W	1000	2.5	3	White	1	18.000	6108175
VL-3Q2.5 2 W	2000	2.5	3	White	1	36.000	6108176
VL-3Q2.5 3 W	3000	2.5	3	White	1	54.000	6108177
VL-3Q2.5 4 W	4000	2.5	3	White	1	72.000	6108178
VL-3Q2.5 5 W	5000	2.5	3	White	1	90.000	6108179
VL-3Q2.5 6 W	6000	2.5	3	White	1	108.000	6108180
VL-3Q2.5 7 W	7000	2.5	3	White	1	126.000	6108181
VL-3Q2.5 8 W	8000	2.5	3	White	1	144.000	6108182
VL-3Q2.5 9 W	9000	2.5	3	White	1	162.000	6108183
VL-3Q2.5 10 W	10000	2.5	3	White	1	180.000	6108184

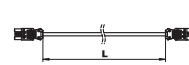

Connection cable 3 x 2.5 mm² in the version socket – connector with GST18i connection system.

3-wire connection cable, PVC, cross-section 2.5 mm², black

Type	Cable length mm	Cross-section mm ²	Number of poles	Colour	Pack. pcs	Weight kg/100 pcs.	Item No.
VL-3Q2.5 1 SW	1000	2.5	3	Black	1	18.000	6108150
VL-3Q2.5 2 SW	2000	2.5	3	Black	1	36.000	6108151
VL-3Q2.5 3 SW	3000	2.5	3	Black	1	54.000	6108152
VL-3Q2.5 4 SW	4000	2.5	3	Black	1	72.000	6108153
VL-3Q2.5 5 SW	5000	2.5	3	Black	1	90.000	6108154
VL-3Q2.5 6 SW	6000	2.5	3	Black	1	108.000	6108155
VL-3Q2.5 7 SW	7000	2.5	3	Black	1	126.000	6108156
VL-3Q2.5 8 SW	8000	2.5	3	Black	1	144.000	6108157
VL-3Q2.5 9 SW	9000	2.5	3	Black	1	162.000	6108158
VL-3Q2.5 10 SW	10000	2.5	3	Black	1	180.000	6108159

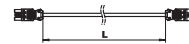

Connection cable 3 x 2.5 mm² in the version socket – connector with GST18i connection system.



Locking

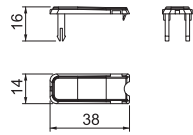
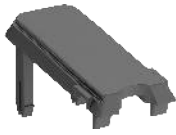

Type	Colour	Pack.	Weight	Item No.
		pcs	kg/100 pcs.	
VR-GST18	Black	10	0.100	6108074
PA Polyamide				

Locking clip for GST18, plug connections, for locking connection cables.

Connector part, 3-pin, screw connection

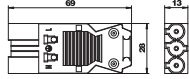

Type	Colour	Pack.	Weight	Item No.
		pcs	kg/100 pcs.	
ST-S GST18i3p SW	Black	1	2.030	6108054
ST-S GST18i3p W	White	1	2.030	6108055

Connector part, 3-pin, type GST18i with screw connection, low height (no slot loss in combination with distributor blocks), for cross-sections of 0.75–2.5 mm², single- and fine-wire cables connectable without end sleeve, for cable diameters between 6.5–10.5 mm (H05VV, NYM), unmounted with strain relief, terminable in situ, 250 V, 16 A.

Stripping length: 31 mm
Insulation removal length: 7 mm

Connector part 3-pin, spring power connection

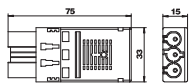

Type	Colour	Pack.	Weight	Item No.
		pcs	kg/100 pcs.	
ST-F GST18i3p SW	Black	1	2.600	6108050
ST-F GST18i3p W	White	1	2.620	6108051

Connector part, 3-pin, type GST18i with spring power connection for rigid cables of 1.5–2.5 mm², single-wire and ultrasonically welded, fine wire cables 1.5 mm² with end sleeves, unmounted with strain relief, can be terminated in situ, 250 V, 16 A.

Two connections per pole, for cables H05VV, NYM (Ø 7.8–10.33 mm), lockable, a lock should be provided for strain relief according to VDE 0628.

Stripping length: 45 mm
Stripped length: 9 mm

Socket section 3-pin, screw connection

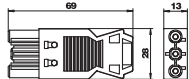

Type	Colour	Pack.	Weight	Item No.
		pcs	kg/100 pcs.	
BT-S GST18i3p SW	Black	1	2.150	6108056
BT-S GST18i3p W	White	1	2.150	6108057

Socket part, 3-pin, type GST18i with screw connection, low height (no slot loss in combination with distributor blocks), for cross-sections of 0.75–2.5 mm², single- and fine-wire cables connectable without end sleeve, for cable diameters between 6.5–10.5 mm (H05VV, NYM), unmounted with strain relief, terminable in situ, 250 V, 16 A.

Stripping length: 31 mm
Insulation removal length: 7 mm

Socket section 3-pin, spring power connection

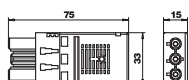

Type	Colour	Pack.	Weight	Item No.
		pcs	kg/100 pcs.	
BT-F GST18i3p SW	Black	1	2.620	6108052
BT-F GST18i3p W	White	1	2.690	6108053

Socket part, 3-pin, type GST18i with spring power connection for rigid cables of 1.5–2.5 mm², single-wire and ultrasonically welded, fine wire cables 1.5 mm² with end sleeves, unmounted with strain relief, can be terminated in situ, 250 V, 16 A.

Two connections per pole, for cables H05VV, NYM (Ø 7.8–10.33 mm), lockable, a lock should be provided for strain relief according to VDE 0628.

Stripping length: 45 mm
Stripped length: 9 mm



Connector part, 5-pin, screw connection

Type	Colour	Pack. pcs	Weight		Item No.
			kg/100	pcs.	
ST-S GST18i5p SW	Black	1	4.330		6108070

Connector part, 5-pin, type GST18i, with screw connection for 1.5–2.5 mm² cables, single and fine-wire, with strain relief, one connection per pin, unmounted, for cables H05VV (Ø 9.5–13.5) NYM and (Ø 10.5–13.5 mm), lockable, according to the strain relief in VDE 0628 a lock should be planned, 250 V, 16 A.

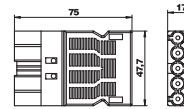

Stripping length: 8 mm
Jacket removal length: 46 mm

Socket section 5-pin, screw connection

Type	Colour	Pack. pcs	Weight		Item No.
			kg/100	pcs.	
BT-S GST18i5p SW	Black	1	4.550		6108072

Socket part, 5-pin, type GST18i, with screw connection for 1.5 to 2.5 mm² cables, single and fine-wire, with strain relief, one connection per pin, unmounted, for cables H05VV (Ø 9.5 – 13.5) NYM and (Ø 10.5 to 13.5 mm), lockable, according to the strain relief in VDE 0628 a lock should be planned, 250 V, 16 A.

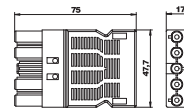

Stripping length: 8 mm
Jacket removal length: 46 mm

Distributor block, 3-pin, T-shaped

Type	Colour	Pack. pcs	Weight		Item No.
			kg/100	pcs.	
VB-T GST18i3p	Black	1	2.540		6108084

T distributor with lock, type GST18i, one input with 3-pin connector part and two outputs with 3-pin socket part.

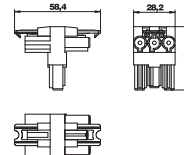

Distributor block 3-pin

Type	Colour	Pack. pcs	Weight		Item No.
			kg/100	pcs.	
VB-3 GST18i3p	Black	1	3.590		6108080
VB-5 GST18i3p	Black	1	5.590		6108082

Distributor block with lock, type GST18i, one input with plug section 3-pin and three outputs with socket section 3-pin.

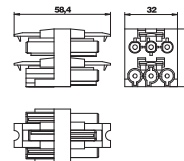

Distributor block, 3-pole

Type	Colour	Pack. pcs	Weight		Item No.
			kg/100	pcs.	
VB-2 GST18i3p	Black	1	3.300		6108086

Distributor block with lock, type GST18i, 1 input with 3-pin plug section and 2 outputs with 3-pin socket section.

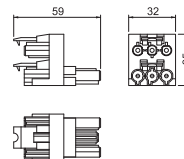

Connector part, 3-pin, screw connection

Type	Colour	Pack. pcs	Weight		Item No.
			kg/100	pcs.	
ST-S4 GST18i3 SW	Black	1	1.600		6108060
ST-S4 GST18i3 W	White	1	1.600		6108062

Connector part, 3-pin, type GST18i with screw connection for cables of 1.5–4.0 mm² and cable diameters between 10.5–14.5 mm (H05VV, NYM), unmounted with strain relief, terminable in situ, 250 V, 16 A.

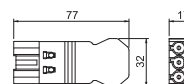

Socket section 3-pin, screw connection

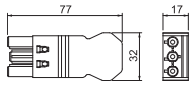

Type	Colour	Pack. Weight		Item No.
		pcs	kg/100 pcs.	
BT-S4 GST18i3 SW	Black	1	1.600	6108064
BT-S4 GST18i3 W	White	1	1.600	6108066

PA Polyamide

Socket section, 3-pin, type GST18i with screw connection for cables of 1.5–4.0 mm² and for cable diameters between 10.5–14.5 mm (H05VV, NYM), unmounted with strain relief, terminable in situ, 250 V, 16 A.



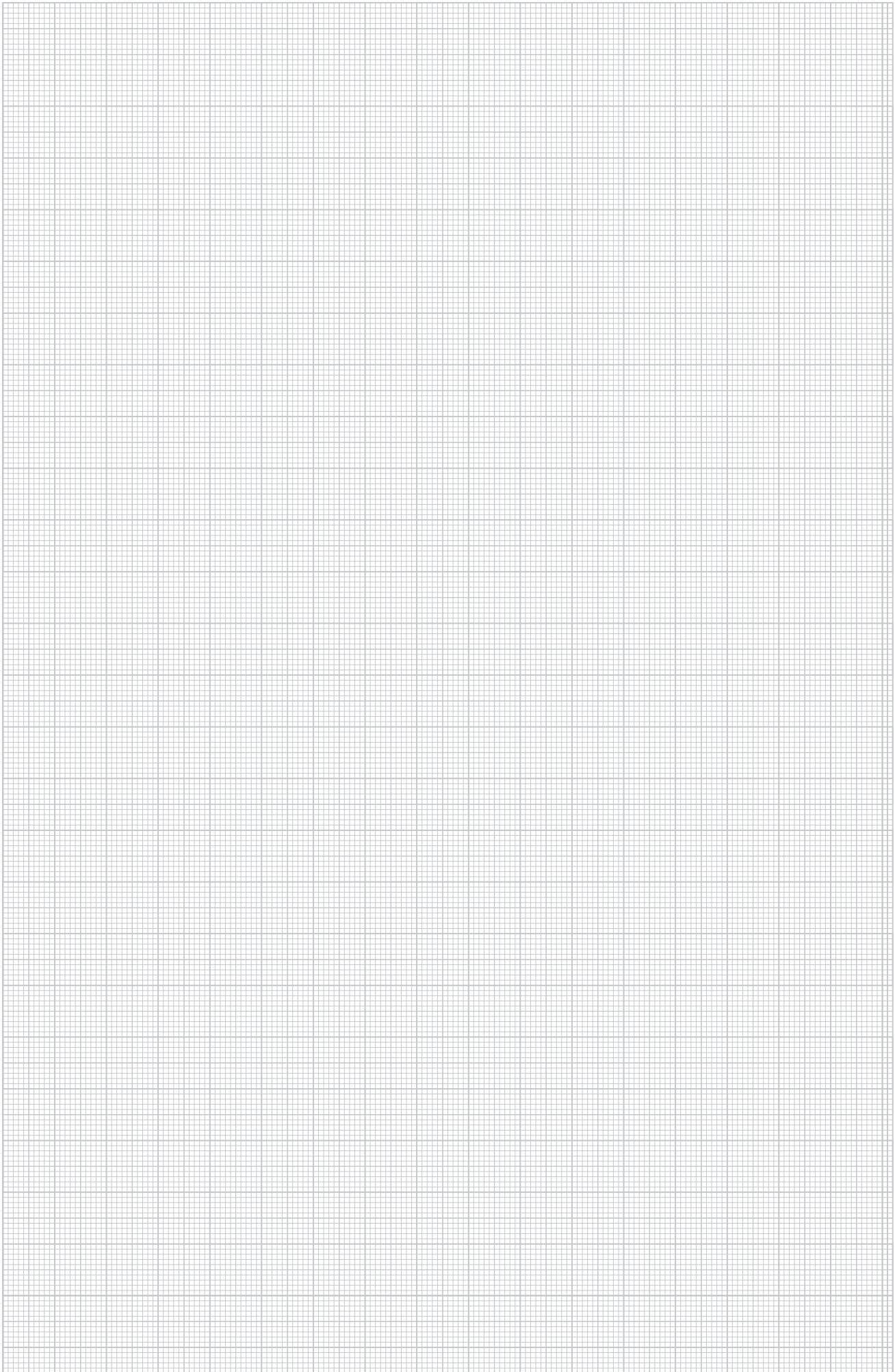



Workplace solutions – Deskboxes and Flexkanal

Deskboxes by OBO offer direct access to power, data and multimedia connections for any workplace and in offices and meeting and conference rooms. For individual requirements, 3 different Deskbox solutions are available in high-quality materials and elegant designs:

- Freely locatable Deskbox DB
- Lowerable Deskbox DBV
- Foldable Deskbox DBK



Workplace solutions – Deskboxes and Flexkanal

	DB – ready-for-connection Deskbox, freely placeable	100
	DBV – ready-for-connection Deskbox, lowerable	105
	DBK – ready-for-connection Deskbox, foldable	107
	Flexkanal and installation accessories	109

Deskbox DB, freely placeable, 3 sockets

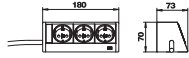

Type	Version	Pack.		Weight	Item No.
		pcs	kg/100 pcs.		
DB-5A3 D3S	Housing, silver anodised	1	66.000		6116930

Alu Aluminium
EL Anodised

Ready-for-connection Deskbox with connection cable, cable outlet on the left housing cover, freely placeable.

Equipment:

- Three protection contact sockets in 0° connection direction, incl. 3.0 m power cable with angular connector CEE 7/7.

Deskbox DB, with fastening clamp, 3 sockets

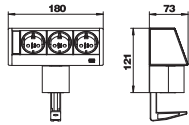

Type	Version	Pack.		Weight	Item No.
		pcs	kg/100 pcs.		
DB-1B3 D3S	Housing, silver anodised	1	102.000		6116930

Alu Aluminium
EL Anodised

Deskbox with connection cable, cable outlet at the bottom of the profile with a fastening clamp for tabletop thicknesses of 8 to 40 mm.

Equipment:

- Three black protection contact sockets in 0° connection direction, incl. 3.0 m power cable with angular connector CEE 7/7.

Deskbox DB, without fastening material, 3 sockets



Type	Version	Pack.		Weight	Item No.
		pcs	kg/100 pcs.		
DB-0B3 D3S	Housing, silver anodised	1	66.000		6116930

Alu Aluminium
EL Anodised

Deskbox with connection cable, cable outlet at the bottom of the profile, without fastening material, combinable with the fastening solutions listed in the accessories.

Equipment:

- Three black protection contact sockets in 0° connection direction, incl. 3.0 m power cable with angular connector CEE 7/7.

Deskbox DB, freely placeable, 3 sockets, 2x RJ45 Cat. 6

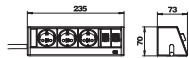

Type	Version	Pack.		Weight	Item No.
		pcs	kg/100 pcs.		
DB-5A3 D3S2K	Housing, silver anodised	1	86.000		6116933

Alu Aluminium
EL Anodised

Deskbox with connection cable, cable outlet on the left and right housing cover, freely placeable using non-slip support points.

Equipment:

- Three black protective contact sockets in 0° connection direction, incl. 3.0 m power cable with angular connector CEE 7/7, cable exit on the left housing cover.
- Two data technology couplings RJ45 to RJ45, 1:1 switched, Cat. 6 shielded, cable exit on the right housing cover.



Deskbox DB, with fastening clamp, 3 switched sockets, 2x RJ45 Cat. 6

Type	Version	Pack. pcs	Weight kg/100 pcs.	Item No.
DB-1B3 D3S2K	Housing, silver anodised	1	122.000	6116942
Alu	Aluminium			
EL	Anodised			

Deskbox with connection cable, cable outlet at the bottom of the profile with two fastening clamps for tabletop thicknesses of 8 to 40 mm.

Equipment:

- Three black protection contact sockets in 0° connection direction, incl. 3.0 m power cable with angular connector CEE 7/7.
- Two data technology couplings RJ45 to RJ45, 1:1 switched, Cat. 6 shielded.

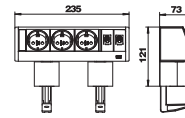

Deskbox DB, without fastening material, 3 sockets, 2x RJ45 Cat. 6

Type	Version	Pack. pcs	Weight kg/100 pcs.	Item No.
DB-0B3 D3S2K	Housing, silver anodised	1	85.700	6116945
Alu	Aluminium			
EL	Anodised			

Deskbox with connection cable, cable outlet at the bottom of the profile, without fastening material, combinable with the fastening solutions listed in the accessories.

Equipment:

- Three black protection contact sockets in 0° connection direction, incl. 3.0 m power cable with angular connector CEE 7/7.
- Two data technology couplings RJ45 to RJ45, 1:1 switched, Cat. 6 shielded.

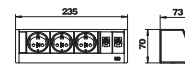

Deskbox DB, freely placeable, 2+2 sockets, 2x RJ45 Cat. 6

Type	Version	Pack. pcs	Weight kg/100 pcs.	Item No.
DB-0A3 D22SR2K	Housing, silver anodised	1	100.000	6116918
Alu	Aluminium			
EL	Anodised			

Deskbox with connection cable, cable outlet on the left and right housing cover, freely placeable using non-slip support points.

Equipment:

- Two black protection contact sockets in 0° connection direction, incl. 3.0 m power cable with angular connector CEE 7/7, cable exit on the left housing cover.
- Two red protection contact sockets in 0° connection direction, incl. 3.0 m power cable with angular connector CEE 7/7, cable exit on the left housing cover.
- Two data technology couplings RJ45 to RJ45, 1:1 switched, Cat. 6 shielded, cable exit on the right housing cover.

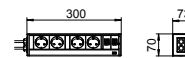

Deskbox DB, with fastening clamp, 1+4 switched sockets

Type	Version	Pack. pcs	Weight kg/100 pcs.	Item No.
DB-1B3 D1.4S	Housing, silver anodised	1	157.000	6116948
Alu	Aluminium			
EL	Anodised			

Deskbox with connection cable, cable outlet at the bottom of the profile with two fastening clamps for tabletop thicknesses of 8 to 40 mm.

Equipment:

- Five black protective contact sockets in 0° connection direction, of which 1 socket is for continuous current and four sockets can be switched using a one-way switch (lit in blue), incl. 3.0 m power cable with angular connector CEE 7/7.

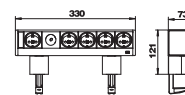

Deskbox DB, without fastening material, 1+4 switched sockets

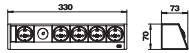

Type	Version	Pack. pcs	Weight kg/100 pcs.	Item No.
DB-0B3 D1.4S	Housing, silver anodised	1	120.000	6116951
Alu	Aluminium			
EL	Anodised			

Deskbox with connection cable, cable outlet at the bottom of the profile, without fastening material, combinable with the fastening solutions listed in the accessories.

Equipment:

- Five black protective contact sockets in 0° connection direction, of which 1 socket is for continuous current and four sockets can be switched using a one-way switch (lit in blue), incl. 3.0 m power cable with angular connector CEE 7/7.

Deskbox DB, with fastening clamp, 1+4 switched sockets, 2x RJ45 Cat. 6

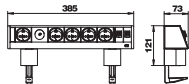

Type	Version	Pack. pcs	Weight kg/100 pcs.	Item No.
DB-1B3 D1.4S2K	Housing, silver anodised	1	177.000	6116954
Alu	Aluminium			
EL	Anodised			

Deskbox with connection cable, cable outlet at the bottom of the profile with two fastening clamps for tabletop thicknesses of 8 to 40 mm.

Equipment:

- Five black protective contact sockets in 0° connection direction, of which 1 socket is for continuous current and four sockets can be switched using a one-way switch (lit in blue), incl. 3.0 m power cable with angular connector CEE 7/7.
- Two data technology couplings RJ45 to RJ45, 1:1 switched, Cat. 6 shielded.

Deskbox DB, without fastening material, 1+4 switched sockets, 2x RJ45 Cat. 6

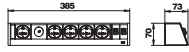

Type	Version	Pack. pcs	Weight kg/100 pcs.	Item No.
DB-0B3 D1.4S2K	Housing, silver anodised	1	140.000	6116957
Alu	Aluminium			
EL	Anodised			

Deskbox with connection cable, cable outlet at the bottom of the profile, without fastening material, combinable with the fastening solutions listed in the accessories.

Equipment:

- Five black protective contact sockets in 0° connection direction, of which 1 socket is for continuous current and four sockets can be switched using a one-way switch (lit in blue), incl. 3.0 m power cable with angular connector CEE 7/7.
- Two data technology couplings RJ45 to RJ45, 1:1 switched, Cat. 6 shielded.

Deskbox DB, with fastening clamp, 3 sockets, VGA, mini jack, USB, 2x RJ45 Cat. 6

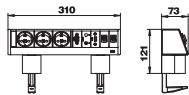

Type	Version	Pack. pcs	Weight kg/100 pcs.	Item No.
DB-M1B3 D3S2K	Housing, silver anodised	1	186.000	6116960
Alu	Aluminium			
EL	Anodised			

Deskbox with connection cable, cable outlet at the bottom of the profile with two fastening clamps for tabletop thicknesses of 8 to 40 mm.

Equipment:

- Three black protection contact sockets in 0° connection direction, incl. 3.0 m power cable with angular connector CEE 7/7.
- One VGA 15-pin HDD socket, incl. 3.0 m connection cable with connector.
- One audio jack socket 3.5 mm, incl. 3.0 m connection cable with connector.
- One USB 2.0, type A socket, incl. 3.0 m connection cable with type A connector.
- Two data technology couplings RJ45 to RJ45, 1:1 switched, Cat. 6 shielded.



Deskbox DB, without fastening material, 3 sockets, VGA, mini jack, USB, 2x RJ45 Cat. 6

Type	Version	Pack. pcs	Weight kg/100 pcs.	Item No.
DB-M0B3 D3S2K	Housing, silver anodised	1	150.000	6116963
Alu	Aluminium			
EL	Anodised			

Deskbox with connection cable, cable outlet at the bottom of the profile, without fastening material, combinable with the fastening solutions listed in the accessories.

Equipment:

- Three black protection contact sockets in 0° connection direction, incl. 3.0 m power cable with angular connector CEE 7/7.
- One VGA 15-pin HDD socket, incl. 3.0 m connection cable with connector.
- One audio jack socket 3.5 mm, incl. 3.0 m connection cable with connector.
- One USB 2.0, type A socket, incl. 3.0 m connection cable with type A connector.
- Two data technology couplings RJ45 to RJ45, 1:1 switched, Cat. 6 shielded.

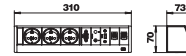

Deskbox DB, with fastening clamp, 3 sockets, HDMI, USB 3.0, 2x RJ45 Cat. 6

Type	Version	Pack. pcs	Weight kg/100 pcs.	Item No.
DB-MH1B3 D3S2K	Housing, silver anodised	1	186.000	6116961
Alu	Aluminium			
EL	Anodised			

Deskbox with connection cable, cable outlet at the bottom of the profile with two fastening clamps for tabletop thicknesses of 8 to 40 mm.

Equipment:

- Three black protection contact sockets in 60° connection direction, incl. 3.0 m power cable with angular connector CEE 7/7.
- One HDMI 1.3 socket, including 3.0 m connection cable with connector.
- One USB 3.0, type A socket, including 3.0 m connection cable with connector type A.
- Two data technology coupling RJ45 on RJ45, 1:1 switched, Cat. 6 shielded.

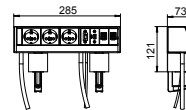

Fastening clamp for Deskbox DB

Type	Colour	Version	Pack. pcs	Weight kg/100 pcs.	Item No.
DBZ-BZ40	Black	Clamping range 8 to 40 mm	1	18.000	6116976
DBZ-BZ75	Black	Clamping range 40 to 75 mm	1	20.000	6116979

Fastening clamp for mounting a Deskbox type DB-... on the tabletop.

Note: For housing widths of 200 mm or more, two fastening clamps are required to mount a Deskbox.

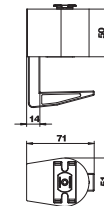

Stainless steel fastening stand for Deskbox DB

Type	Pack. pcs	Weight kg/100 pcs.	Item No.
DBZ-BFE	1	34.000	6116982

Stainless steel fastening stand for fixed mounting of a Deskbox type DB-... on a tabletop. It is mounted using a drill hole (Ø16 mm) in the tabletop.

Note: Can be used in tabletops of up to 50 mm thickness.

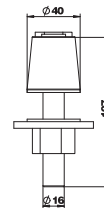

Fastening set for table mounting, for Deskbox DB

Type	Pack. pcs	Weight kg/100 pcs.	Item No.
DBZ-BST	1	2.300	6116985

Fastening set for fixed mounting of Deskbox type DB-... on the tabletop. It is mounted using a drill hole (Ø10 mm) in the tabletop.

Note: The included fastening screws (M4 x 40 mm) can be used for tabletops of up to a maximum thickness of 32 mm.

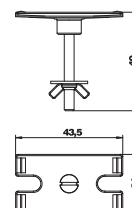

Fastening set for under-table mounting, for Deskbox DB

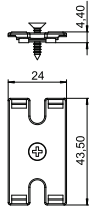

Type
DBZ-BSUT

Pack.	Weight	Item No.
pcs	kg/100 pcs.	
1	100.000	6116986

Fastening set for fixed mounting of Deskbox type DB-... under the tabletop. It is mounted on the tabletop using two wood screws.

Flexkanal holder for Deskbox DB

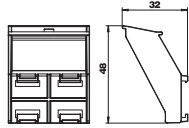

Type
DBZ-FLKB Black

Pack.	Weight	Item No.
pcs	kg/100 pcs.	
1	1.100	6116991

Flexkanal holder for Deskbox, type DB, for secure connection of a Flexkanal to the Deskbox.

Note: Can only be used for mounting on the tabletop using fastening clamps.



Deskbox DBV, 2 sockets

Type	Pack.	Weight	Item No.
	pcs	kg/100 pcs.	
DBV-A3A D2S	1	93.230	6116854
DBV-A3E D2S	1	99.230	6116858

- Alu Aluminium
- EL Anodised

Lowerable Deskbox with connection cable for fixed installation on a tabletop, plastic fastening sleeve, painted accordingly in cover shade. It is mounted using a drill hole (Ø102 mm) in the tabletop.

Equipment:

- Two black protection contact sockets in 60° connection direction, incl. 3.0 m power cable with angular connector CEE 7/7.

Note: Can be used in tabletops of up to 50 mm thickness.

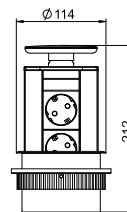

Deskbox DBV, 3 sockets

Type	Pack.	Weight	Item No.
	pcs	kg/100 pcs.	
DBV-A3A D3S	1	98.230	6116862
DBV-A3E D3S	1	106.230	6116866

- Alu Aluminium
- EL Anodised

Lowerable Deskbox with connection cable for fixed installation on a tabletop, plastic fastening sleeve, painted accordingly in cover shade. It is mounted using a drill hole (Ø102 mm) in the tabletop.

Equipment:

- Three black protection contact sockets in 60° connection direction, incl. 3.0 m power cable with angular connector CEE 7/7.

Note: Can be used in tabletops of up to 50 mm thickness.

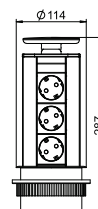

Deskbox DBV, 2 sockets, 2x RJ45 Cat. 6

Type	Pack.	Weight	Item No.
	pcs	kg/100 pcs.	
DBV-A3A D2S2K	1	98.230	6116870
DBV-A3E D2S2K	1	106.230	6116874

- Alu Aluminium
- EL Anodised

Lowerable Deskbox with connection cable for fixed installation on a tabletop, plastic fastening sleeve, painted accordingly in cover shade. It is mounted using a drill hole (Ø102 mm) in the tabletop.

Equipment:

- Two black protection contact sockets in 60° connection direction, incl. 3.0 m power cable with angular connector CEE 7/7.
- Two data technology couplings RJ45 to RJ45, 1:1 switched, Cat. 6 shielded.

Note: Can be used in tabletops of up to 50 mm thickness.

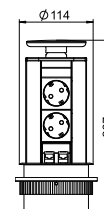

Deskbox DBV, 3 sockets, 2x RJ45 Cat. 6

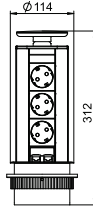

Type

DBV-A3A D3S2K	1	103.230	6116878
DBV-A3E D3S2K	1	111.230	6116882

Pack. pcs	Weight kg/100 pcs.	Item No.
1	103.230	6116878
1	111.230	6116882

- Alu Aluminium
- EL Anodised

Lowerable Deskbox with connection cable for fixed installation on a tabletop, plastic fastening sleeve, painted accordingly in cover shade. It is mounted using a drill hole (Ø102 mm) in the tabletop.

Equipment:

- Three black protection contact sockets in 60° connection direction, incl. 3.0 m power cable with angular connector CEE 7/7.
- Two data technology couplings RJ45 to RJ45, 1:1 switched, Cat. 6 shielded.

Note: Can be used in tabletops of up to 50 mm thickness.

Deskbox DBV, 2 sockets, VGA, mini jack, 2x RJ45 Cat. 6

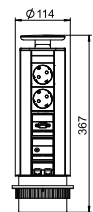

Type

DBV-MA3A D3S2K	1	118.230	6116886
DBV-MA3E D3S2K	1	126.230	6116890

Pack. pcs	Weight kg/100 pcs.	Item No.
1	118.230	6116886
1	126.230	6116890

- Alu Aluminium
- EL Anodised

Lowerable Deskbox with connection cable for fixed installation on a tabletop, plastic fastening sleeve, painted accordingly in cover shade. It is mounted using a drill hole (Ø102 mm) in the tabletop.

Equipment:

- Two black protection contact sockets in 60° connection direction, incl. 3.0 m power cable with angular connector CEE 7/7.
- One VGA 15-pin HDD socket, incl. 3.0 m connection cable with connector.
- One audio jack socket 3.5 mm, incl. 3.0 m connection cable with connector.
- Two data technology couplings RJ45 to RJ45, 1:1 switched, Cat. 6 shielded.

Note: Can be used in tabletops of up to 50 mm thickness.

Deskbox DBV, 2 sockets, HDMI, 2x RJ45 Cat. 6

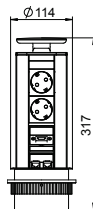

Type

DBV-MHA3A D2S2K	1	108.230	6116887
DBV-MHA3E D2S2K	1	116.230	6116888

Pack. pcs	Weight kg/100 pcs.	Item No.
1	108.230	6116887
1	116.230	6116888

- Alu Aluminium
- EL Anodised

Lowerable Deskbox with connection cable for fixed installation on a tabletop, plastic fastening sleeve, painted accordingly in cover shade. It is mounted using a drill hole (Ø102 mm) in the tabletop.

Equipment:

- Two black protection contact sockets in 60° connection direction, incl. 3.0 m power cable with angular connector CEE 7/7.
- One HDMI 1.3 socket, including 3.0 m connection cable with connector.
- Two data technology couplings RJ45 to RJ45, 1:1 switched, Cat. 6 shielded.

Note: Can be used in tabletops of up to 60 mm thickness.

Circular band saw for Deskbox DBV

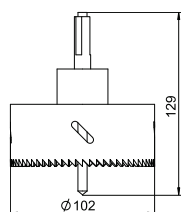

Type

DBZ-LS	1	100.000	6116994
---------------	---	---------	----------------

Pack. pcs	Weight kg/100 pcs.	Item No.
1	100.000	6116994

Circular band saw as a mounting tool for precise installation of a Deskbox of type DBV, drill hole diameter 102 mm.



Deskbox DBK, 3 sockets

Type	Pack.	Weight	Item No.
	pcs	kg/100 pcs.	
DBK2-E3 D3S	1	133.860	6116800

V2A Stainless steel, grade 304

Foldable Deskbox with connection cable for fixed installation in a tabletop, housing made of brushed stainless steel with brush bar as cable outlet. It is mounted using a 195 x 157 mm installation opening in the tabletop.



Equipment:

- Three black protective contact sockets in 60° connection direction, incl. 3.0 m power cable with angular connector CEE 7/7.

Note: Can be used in tabletops of up to 50 mm thickness.

Deskbox DBK, 4 sockets

Type	Pack.	Weight	Item No.
	pcs	kg/100 pcs.	
DBK2-E4 D4S	1	163.860	6116804

V2A Stainless steel, grade 304

Foldable Deskbox with connection cable for fixed installation in a tabletop, housing made of brushed stainless steel with brush bar as cable outlet. It is mounted using a 245 x 157 mm installation opening in the tabletop.



Equipment:

- Four black protective contact sockets in 60° connection direction, incl. 3.0 m power cable with angular connector CEE 7/7.

Note: Can be used in tabletops of up to 50 mm thickness.

Deskbox DBK, 2 sockets, 2x RJ45 Cat. 6

Type	Pack.	Weight	Item No.
	pcs	kg/100 pcs.	
DBK2-D3 D2S2K	1	178.800	6116802

V2A Stainless steel, grade 304

Foldable Deskbox with connection cable for fixed installation in a tabletop, housing made of brushed stainless steel with brush bar as cable outlet. It is mounted using a 195 x 157 mm installation opening in the tabletop.



Equipment:

- Two black protective contact sockets in 60° connection direction, incl. 3.0 m power cable with angular connector CEE 7/7.
- Two data technology couplings RJ45 to RJ45, 1:1 switched, Cat. 6 shielded.

Note: Can be used in tabletops of up to 50 mm thickness.

Deskbox DBK, 3 sockets, 2x RJ45 Cat. 6

Type	Pack.	Weight	Item No.
	pcs	kg/100 pcs.	
DBK2-D4 D3S2K	1	163.860	6116806

V2A Stainless steel, grade 304

Foldable Deskbox with connection cable for fixed installation in a tabletop, housing made of brushed stainless steel with brush bar as cable outlet. It is mounted using a 245 x 157 mm installation opening in the tabletop.



Equipment:

- Three black protective contact sockets in 60° connection direction, incl. 3.0 m power cable with angular connector CEE 7/7.
- Two data technology couplings RJ45 to RJ45, 1:1 switched, Cat. 6 shielded.

Note: Can be used in tabletops of up to 50 mm thickness.



Deskbox DBK, 3 sockets, VGA, mini jack, 2x RJ45 Cat. 6



Type

DBK2-M5V D3S2K

V2A Stainless steel, grade 304

Pack. pcs	Weight		Item No.
	kg/100	pcs.	
1	278.000		6116808

Foldable Deskbox with connection cable for fixed installation in a tabletop, housing made of brushed stainless steel with brush bar as cable outlet. It is mounted using a 295 x 157 mm installation opening in the tabletop.

Equipment:

- Three black protective contact sockets in 60° connection direction, incl. 3.0 m power cable with angular connector CEE 7/7.
- One VGA 15-pin HDD socket, incl. 3.0 m connection cable with connector.
- One audio jack socket 3.5 mm, incl. 3.0 m connection cable with connector.
- Two data technology couplings RJ45 to RJ45, 1:1 switched, Cat. 6 shielded.

Note: Can be used in tabletops of up to 50 mm thickness.

Deskbox DBK, 2 sockets, HDMI, 2x RJ45 Cat. 6



Type

DBK2-M4H D2S2K

V2A Stainless steel, grade 304

Pack. pcs	Weight		Item No.
	kg/100	pcs.	
1	173.760		6116810

Foldable Deskbox with connection cable for fixed installation in a tabletop, housing made of brushed stainless steel with brush bar as cable outlet. It is mounted using a 245 x 157 mm installation opening in the tabletop.

Equipment:

- Two black protective contact sockets in 60° connection direction, incl. 3.0 m power cable with angular connector CEE 7/7.
- One HDMI 1.3 socket, including 3.0 m connection cable with connector.
- Two data technology couplings RJ45 to RJ45, 1:1 switched, Cat. 6 shielded.

Note: Can be used in tabletops of up to 50 mm thickness.



Flexkanal

Type	Length		Colour	Pack. Weight		Item No.
	mm			m	kg/100 m	
FLK-2K LGR	1000		Light grey	1	28.800	6154922
FLK-2K SWGR	1000		Black-grey	1	28.800	6154930

The Flexkanal runs your cables ordered and protected to the desk. It connects the Deskbox with the dado duct or with the floor connection box. When extended, the Flexkanal is 1,000 mm long, 60 mm wide and 20 mm high.

The duct consists of two chambers, capacity per chamber:
two cables of 8.5 mm diameter or three cables of 7.5 mm diameter or
four cables of 7.0 mm diameter or five cables of 6.0 mm diameter.



Holder with strain relief for Flexkanal

Type	Colour	Pack. pcs	Weight		Item No.
			kg/100 pcs.		
FLK-HL ZL	Anthracite grey	1	10.500		6154961

The holder possesses two integrated strain reliefs and can be screwed on. A Flexkanal can be mounted directly on the holder.

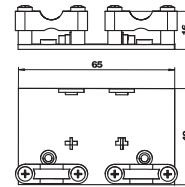

Fastening clamp for Flexkanal

Type	Colour	Pack. pcs	Weight		Item No.
			kg/100 pcs.		
FLK-BEF	Alu	1	0.150		6154968

The Flexkanal is suspended from the fastening clamp. The holder is fastened using a countersunk union.

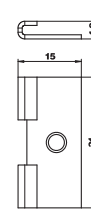

Floor rail for Flexkanal

Type	Length		Colour	Pack. pcs	Weight		Item No.
	mm				kg/100 pcs.		
FLK-BS1	1000		Anthracite grey	1	19.400		6154980
FLK-BS2	2000		Anthracite grey	1	19.400		6154983

The Flexkanal is pushed directly into the floor rail. The ramp on both sides reduces the risk of stumbling.

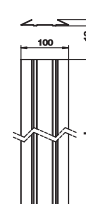

T branch for Flexkanal

Type	Colour	Pack. pcs	Weight		Item No.
			kg/100 pcs.		
FLK-TAZ	Anthracite grey	1	8.700		6154965

T branch for supply of working places with the Flexkanal.

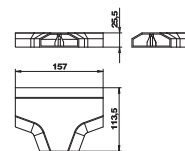



Modul 45® and standard – Suspended power supply units VH / VHF

Suspended energy distributors for workplaces and machines in industry, the trades and in training areas. The power supply units can be positioned freely in the room. The supply comes from the ceiling. They can be equipped flexibly from power, data and media technology through to work media such as compressed air.



Modul 45® and standard – Suspended power supply units VH / VHF

	VH – pre-wired power supply units IP20	112
	VH – empty housing and installation accessories IP20	114
	VH – empty housing and installation accessories IP20, pure white	117
	VH – device installation solutions for empty housing IP20	118
	VHF – empty housing and installation accessories IP44	120
	VH – device installation solutions for empty housing IP44	122
	Fastening solutions for power supply units VH and VHF	123



VH-4 power supply unit, 4x protective contact socket

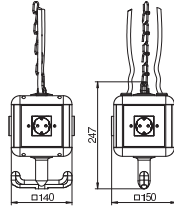

Type	Colour	Pack. Weight		Item No.
		pcs	kg/100 pcs.	
VH-4 4SD	Graphite black	1	95.000	6109802

PA Polyamide

Housing equipped and pre-wired with suspension lug, grip hook and four cover plates.

Equipped as follows: 4x single protective contact sockets 16 A/250 V with increased touch protection, pre-wired for two AC currents, connection via 2x 3-pin terminals, 1x CEE socket 16 A/415 V, with partition for circuit separation.

VH-4 power supply unit, 3x protective contact socket, 1x CEE 16 A

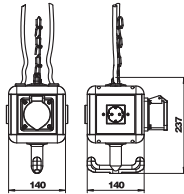

Type	Colour	Pack. Weight		Item No.
		pcs	kg/100 pcs.	
VH-4 3SD1C16	Graphite black	1	115.700	6109804

PA Polyamide

Housing equipped and pre-wired with suspension lug, grip hook and four cover plates.

Equipped as follows: 3x single protective contact sockets 16 A/250 V with increased touch protection, pre-wired for an AC current, connection via 1x 3-pin terminal, 1x CEE socket 16 A/415 V, with partition for circuit separation.

VH-4 power supply unit, 4x earthing pin socket

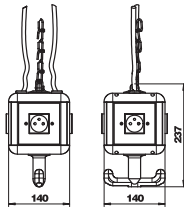

Type	Colour	Pack. Weight		Item No.
		pcs	kg/100 pcs.	
VH-4 4SF	Graphite black	1	95.000	6109806

PA Polyamide

Housing equipped and pre-wired with suspension lug, grip hook and four cover plates.

Equipped as follows: 4x single sockets with earthing pin 16 A/250 V with increased touch protection, pre-wired for two AC currents, connection via 2x 3-pin terminals, 1x CEE socket 16 A/415 V, with partition for circuit separation.

VH-4 power supply unit, 3x earthing pin socket, 1x CEE 16 A

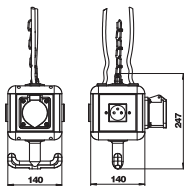

Type	Colour	Pack. Weight		Item No.
		pcs	kg/100 pcs.	
VH-4 3SF1C16	Graphite black	1	115.700	6109808

PA Polyamide

Housing equipped and pre-wired with suspension lug, grip hook and four cover plates.

Equipped as follows: 3x single sockets with earthing pin 16 A/250 V with increased touch protection, pre-wired for an AC current, connection via 1x 3-pin terminal, 1x CEE socket 16 A/415 V, with partition for circuit separation.

VH-4 power supply unit, 4x protective contact socket, with compressed air connection

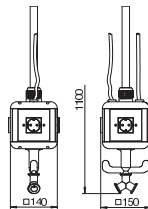

Type	Colour	Pack. Weight		Item No.
		pcs	kg/100 pcs.	
VH-4L 4SD	Graphite black	1	428.600	6109812

PA Polyamide

Housing equipped and pre-wired, with 1 m pipe 1/2" and connection for compressed air hose 13 x 3.5 mm and 2-way distributor 1/2", with suspension lug, grip hook and four cover plates.

Equipped as follows: 4x single protective contact sockets 16 A/250 V with increased touch protection, pre-wired for two AC currents, connection via 2x 3-pin terminals, 1x CEE socket 16 A/415 V, with partition for circuit separation.

VH-4 power supply unit, 3x protective contact socket, 1x CEE 16 A, with compressed air connection

Type	Colour	Pack. pcs	Weight kg/100 pcs.	Item No.
VH-4L 3SD1C16	Graphite black	1	380.000	6109814

PA Polyamide

Housing equipped and pre-wired, with 1 m pipe 1/2" and connection for compressed air hose 13 x 3.5 mm and 2-way distributor 1/2", with suspension lug, grip hook and four cover plates.

Equipped as follows: 3x single protective contact sockets 16 A/250 V with increased touch protection, pre-wired for an AC current, connection via 1x 3-pin terminal, 1x CEE socket 16 A/415 V, with partition for circuit separation.

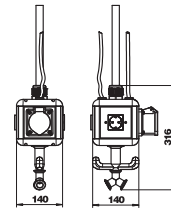

VH-4 power supply unit, 4x earthing pin socket, with compressed air connection

Type	Colour	Pack. pcs	Weight kg/100 pcs.	Item No.
VH-4L 4SF	Graphite black	1	428.600	6109816

PA Polyamide

Housing equipped and pre-wired, with 1 m pipe 1/2" and connection for compressed air hose 13 x 3.5 mm and 2-way distributor 1/2", with suspension lug, grip hook and four cover plates.

Equipped as follows: 4x single sockets with earthing pin 16 A/250 V with increased touch protection, pre-wired for two AC currents, connection via 2x 3-pin terminals, 1x CEE socket 16 A/415 V, with partition for circuit separation.

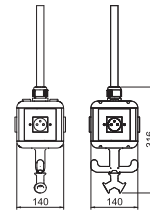

VH-4 power supply unit, 3x earthing pin socket, 1x CEE 16 A, with compressed air connection

Type	Colour	Pack. pcs	Weight kg/100 pcs.	Item No.
VH-4L 3SF1C16	Graphite black	1	440.000	6109818

PA Polyamide

Housing equipped and pre-wired, with 1 m pipe 1/2" and connection for compressed air hose 13 x 3.5 mm and 2-way distributor 1/2", with suspension lug, grip hook and four cover plates.

Equipped as follows: 3x single sockets with earthing pin 16 A/250 V with increased touch protection, pre-wired for an AC current, connection via 1x 3-pin terminal, 1x CEE socket 16 A/415 V, with partition for circuit separation.

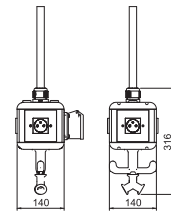

VH-4 power supply unit, empty housing

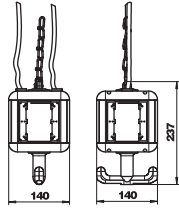

Type	Colour	Pack. Weight		Item No.
		pcs	kg/100 pcs.	
VH-4 LG	Graphite black	1	62.000	6109800

PA Polyamide

Empty housing with suspension lug and grip hook, for the installation of four electrical resources, with included partition. Without cover plates.

VH-4 power supply unit, empty housing, with compressed air connection

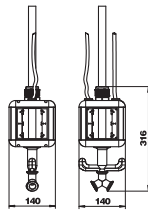

Type	Colour	Pack. Weight		Item No.
		pcs	kg/100 pcs.	
VH-4L LG	Graphite black	1	343.800	6109810

PA Polyamide

Empty housing with 1 m pipe 1/2" and connection for compressed air hose 13 x 3.5 mm and 2-way distributor 1/2". With suspension lug and grip hook, for the installation of four electrical resources, with included partition. Without cover plates.

VH-8 power supply unit, empty housing

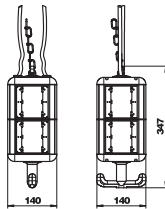

Type	Colour	Pack. Weight		Item No.
		pcs	kg/100 pcs.	
VH-8 LG	Graphite black	1	88.200	6109821

PA Polyamide

Empty housing with suspension lug and grip hook, for the installation of eight electrical resources, with included partition. Without cover plates.

VH-8 power supply unit, empty housing, with cover plates

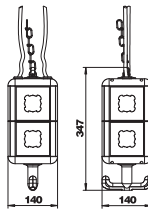

Type	Colour	Pack. Weight		Item No.
		pcs	kg/100 pcs.	
VH-8 LG8P2	Graphite black	1	123.400	6109820

PA Polyamide

Empty housing with suspension lug and grip hook, for the installation of eight electrical resources, with included partition. With eight cover plates for accessories with concealed support ring or support bracket.

VH-8 power supply unit, empty housing, with compressed air connection

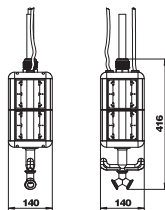

Type	Colour	Pack. Weight		Item No.
		pcs	kg/100 pcs.	
VH-8L LG	Graphite black	1	300.000	6109825

PA Polyamide

Empty housing with 1 m pipe 1/2" and connection for compressed air hose 13 x 3.5 mm and 2-way distributor 1/2". With suspension lug and grip hook, for the installation of electrical resources, with included partition. Without cover plates.

Partition VH-4

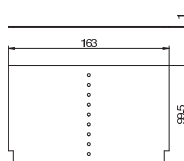

Type	Colour	Pack. Weight		Item No.
		pcs	kg/100 pcs.	
VH-4 TW	Graphite black	1	2.350	6109832

PVC Polyvinylchloride

Additional partition wall for reciprocal insulation of three different power circuits and types. Version for VH-4.

Partition VH-8

Type	Colour	Pack. pcs	Weight kg/100 pcs.	Item No.
VH-8 TW	Graphite black	1	4.890	6109862

PVC Polyvinylchloride

Additional partition wall for reciprocal insulation of three different power circuits and types. Version for VH-8.

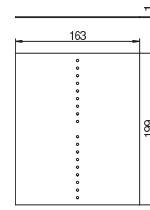

Cover plate VH, for EK and EKR devices

Type	Colour	Pack. pcs	Weight kg/100 pcs.	Item No.
VH-P2	Rape yellow	1	2.300	6109834

PA Polyamide

Cover plate with opening \varnothing 45 mm for the installation of a device with concealed support ring or support clamp.

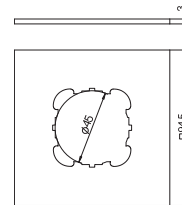

Cover plate VH, for Modul 45 devices, single

Type	Colour	Pack. pcs	Weight kg/100 pcs.	Item No.
VH-P4	Rape yellow	1	2.030	6109840

PA Polyamide

Cover plate to install a single Modul 45 socket.

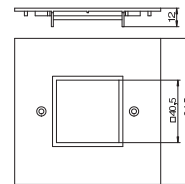

Cover plate VH, for Modul 45 devices, double

Type	Colour	Pack. pcs	Weight kg/100 pcs.	Item No.
VH-P5	Rape yellow	1	1.830	6109836

PA Polyamide

Cover plate to install a double Modul 45 socket.

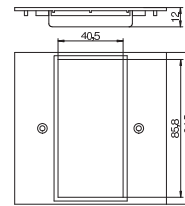

Cover plate VH, for 1x extension socket, type ASD

Type	Colour	Pack. pcs	Weight kg/100 pcs.	Item No.
VH-P7	Rape yellow	1	1.890	6109839

PA Polyamide

Cover plate with opening for the installation of a socket with 38 x 38 mm fastening system.

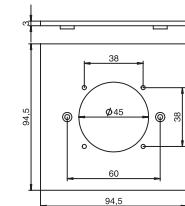

Cover plate VH, for CEE connection unit

Type	Colour	Pack. pcs	Weight kg/100 pcs.	Item No.
VH-P3	Rape yellow	1	1.870	6109838

PA Polyamide

Cover plate with a \varnothing 70 mm opening for the installation of a CEE socket 16/32 A with 60 mm fastening track, including four fastening screws.

Information on equipment:

Max. 2 CEE sockets 16/32 A in a power supply unit VH-4

Max. 4 CEE sockets 16/32 A in a power supply unit VH-8

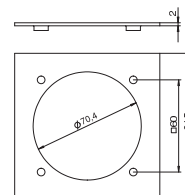

VH cover plate as blanking cover

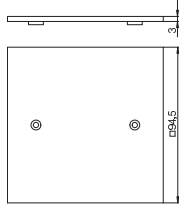

Colour		Pack.	Weight	Item No.
Type		pcs	kg/100 pcs.	
VH-P1	Rape yellow	1	3.000	6109842
PA	Polyamide			

Cover plate as blanking cover.



VH4 power supply unit, empty housing

Type	Colour	Pack. pcs	Weight kg/100 pcs.	Item No.
VH-4 LG RW	Pure white	1	72.000	6109801
PA	Polyamide			

Empty housing with suspension lug and grip hook, for the installation of four electrical resources, with included partition. Without cover plates.

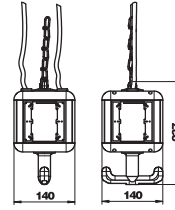

Cover plate VH, for Modul 45 devices, single

Type	Colour	Pack. pcs	Weight kg/100 pcs.	Item No.
VH-P4 RW	Pure white	1	2.000	6109841
PA	Polyamide			

Cover plate to install a single Modul 45 socket.

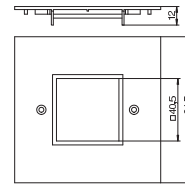

Cover plate VH, for Modul 45 devices, double

Type	Colour	Pack. pcs	Weight kg/100 pcs.	Item No.
VH-P5 RW	Pure white	1	1.830	6109835
PA	Polyamide			

Cover plate to install a double Modul 45 socket.

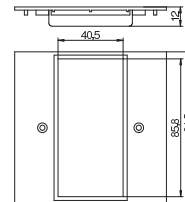

Cover plate VH, for CEE connection unit

Type	Colour	Pack. pcs	Weight kg/100 pcs.	Item No.
VH-P3 RW	Pure white	1	2.000	6109837
PA	Polyamide			

Cover plate with a $\varnothing 70$ mm opening for the installation of a CEE socket 16/32 A with 60 mm fastening track, including four fastening screws.

Information on equipment:

Max. 2 CEE sockets 16/32 A in a power supply unit VH-4

Max. 4 CEE sockets 16/32 A in a power supply unit VH-8

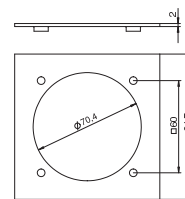

VH cover plate as blanking cover

Type	Colour	Pack. pcs	Weight kg/100 pcs.	Item No.
VH-P1 RW	Pure white	1	3.000	6109843
PA	Polyamide			

Cover plate as blanking cover.

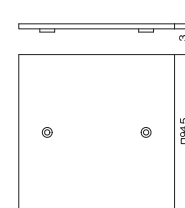

Partition VH-4

Type	Colour	Pack. pcs	Weight kg/100 pcs.	Item No.
VH-4 TW	Graphite black	1	2.350	6109832
PVC	Polyvinylchloride			

Additional partition wall for reciprocal insulation of three different power circuits and types. Version for VH-4.

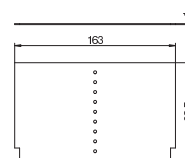

Socket 0°, protective contact, single

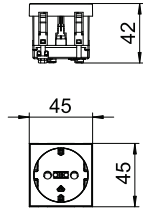

Type	Colour	Pack. Weight		Item No.
		pcs	kg/100 pcs.	
STD-D0 RW1	Pure white	1	4.200	6120008

PC Polycarbonate

Protective contact socket single 0°, with increased touch protection, with screwless terminals, 2-pin, 16 A, 250 V~, with connection terminals to IEC 60884-1.

Socket 33°, protective contact, double

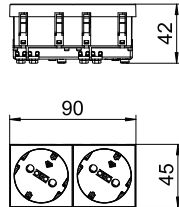

Type	Colour	Pack. Weight		Item No.
		pcs	kg/100 pcs.	
STD-D3 RW2	Pure white	1	7.800	6120102

PC Polycarbonate

Protective contact socket double 33°, with increased touch protection, with screwless terminals, 2-pin, 16 A, 250 V~, with connection terminals to IEC 60884-1.

Socket 0°, with earthing pin, single

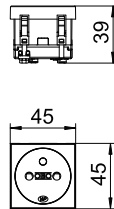

Type	Colour	Pack. Weight		Item No.
		pcs	kg/100 pcs.	
STD-F0 RW1	Pure white	1	4.000	6120152

PC Polycarbonate

Socket with earthing pin single 0°, with increased touch protection with screwless terminals, 2-pin, 16 A, 250 V~, with connection terminals to IEC 60884-1.

Socket 33°, with earthing pin, double

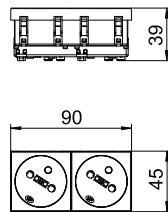

Type	Colour	Pack. Weight		Item No.
		pcs	kg/100 pcs.	
STD-F3 RW2	Pure white	1	7.500	6120242

PC Polycarbonate

Socket with earthing pin double 33°, with increased touch protection with screwless terminals, 2-pin, 16 A, 250 V~, with connection terminals to IEC 60884-1.

Socket 0°, Switzerland, single

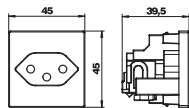

Type	Colour	Pack. Weight		Item No.
		pcs	kg/100 pcs.	
SKS-CH0 RW1	Pure white	1	3.400	6117200

PC Polycarbonate

Socket, single 0°, to Swiss standard (SEV), with screwless terminals, 2-pin, 10 A, 250 V~, type 13, with connection terminals to IEC 60884-1.

Data technology support, 1 module, slanting outlet, type C

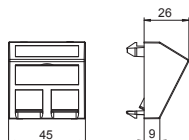

Type	Colour	Pack. Weight		Item No.
		pcs	kg/100 pcs.	
DTS-2C RW1	Pure white	1	1.500	6119250

PC Polycarbonate

The type C data technology support is suitable for accepting the following data connection modules: BTR (Keystone design): Cat. 6A module and UAE module; Corning: modules with Keystone seat; CobiNet: CobiDat KS module; Dätwyler: KS-T, KS-TS, MS-K and KU-T; EKU: E-Stone; Harting: Prelink Keystone Cat. 6A; Fixlink Keystone Cat. 6A; Komos: KDM 500 module; Leoni Kerpen: MegaLine-Connect45 Keystone socket modules; OBO: Type ASM-C6A and ASM-C6A G; R&M: Cat. 6A with Keystone fastening; Rutenbeck: UM and UMflex; SETEC: UKJ and XKJ; Telegärtner: AMJ and UMJ.

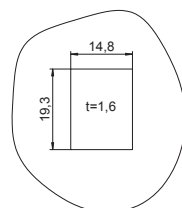

Connection module Cat. 6A, unshielded, snap-in

Type	Pack. pcs	Weight		Item No.
		kg/100 pcs.	pcs.	
ASM-C6A	1	1.050		6117348

Connection module Cat. 6A (ISO) unshielded, with an RJ45 slot. Including a dust cover, a cable tie, a Keystone fastening frame and mounting instructions. Suitable for installation in the data technology supports of type DTG-2C and DTS-2C, support plate of type MTM 2C and MTM 3C, mounting plate of type MPR2 2C, mounting supports of type MTGE2 2C, MTGE2 15 2C and MTGE2 F 2C.

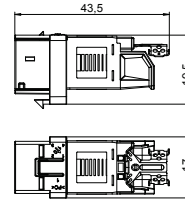

Connection module Cat. 6A, shielded, snap-in

Type	Pack. pcs	Weight		Item No.
		kg/100 pcs.	pcs.	
ASM-C6A G	1	1.630		6117346

Connection module Cat. 6A (ISO) shielded, with an RJ45 slot. Including an EMC screen hood, a dust cover, a cable tie, a Keystone fastening frame and mounting instructions. Suitable for installation in the data technology supports of type DTG-2C and DTS-2C, support plate of type MTM 2C and MTM 3C, mounting plate of type MPR2 2C, mounting supports of type MTGE2 2C, MTGE2 15 2C and MTGE2 F 2C.

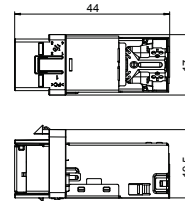

Surface-mounted socket 0° with hinged cover, protective contact, single

Type	Designation	Colour	Pack. pcs	Weight		Item No.
				kg/100 pcs.	pcs.	
ASD-D0 SW	prot. contact w. hinged cov.	Black	1	1.000		6109873

Protective contact extension socket 0° with hinged cover, with screwless terminals, 2-pin, 16 A, 250 V~, with connection terminals to IEC 60884-1. Protection rating: IP44.

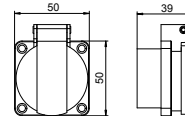

CEE connection unit, 16 A

Type	Pack. pcs	Weight		Item No.
		kg/100 pcs.	pcs.	
CEE-16A	1	19.100		6109874

CEE socket with 60 mm fastening track, 3-pin + N + PE, 400 V, 16 A, 6 h.

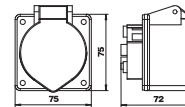

CEE connection unit, 32 A

Type	Pack. pcs	Weight		Item No.
		kg/100 pcs.	pcs.	
CEE-32A	1	20.400		6109876

CEE socket with 60 mm fastening track, 3-pin + N + PE, 400 V, 32 A, 6 h.

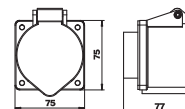

VH-8 power supply unit, empty housing

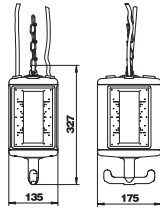

Type	Colour	Pack. Weight		Item No.
		pcs	kg/100 pcs.	
VHF-8 LG	Graphite black	1	105.000	6109822

PA Polyamide

Empty housing with suspension lug and grip hook, for the installation of electrical resources, with included partition. Without cover plates to supply workplaces in wet areas. Protection rating: IP44.

VH-8 power supply unit, empty housing, with compressed air connection

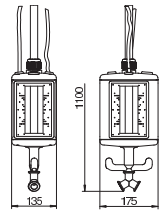

Type	Colour	Pack. Weight		Item No.
		pcs	kg/100 pcs.	
VHF-8L LG	Graphite black	1	400.000	6109827

PA Polyamide

Empty housing with 1 m pipe 1/2" and connection for compressed air hose 13 x 3.5 mm and 2-way distributor 1/2". With suspension lug and grip hook, for the installation of electrical resources, with included partition. Without cover plates to supply workplaces in wet areas. Protection rating: IP44.

Partition VHF, without compressed air connection

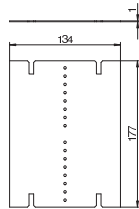

Type	Colour	Pack. Weight		Item No.
		pcs	kg/100 pcs.	
VHF-TW	Graphite black	1	3.520	6109860

PVC Polyvinylchloride

Additional partition wall for reciprocal insulation of three different power circuits and types.

Partition VHF, with compressed air connection

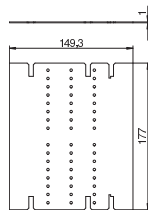

Type	Colour	Pack. Weight		Item No.
		pcs	kg/100 pcs.	
VHF-TW L	Graphite black	1	3.900	6109861

PVC Polyvinylchloride

Additional partition wall for reciprocal insulation of three different power circuits and types.

Cover plate VHF as blanking cover

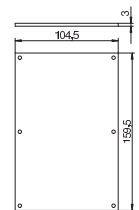

Type	Colour	Pack. Weight		Item No.
		pcs	kg/100 pcs.	
VHF-P1	Rape yellow	1	7.000	6109868

PVC Polyvinylchloride

Cover plate as blanking cover.

Cover plate VHF 1x with fastening system

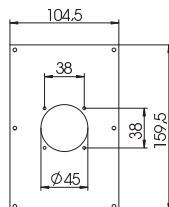

Type	Colour	Pack. Weight		Item No.
		pcs	kg/100 pcs.	
VHF-P7	Rape yellow	1	6.600	6109878

PVC Polyvinylchloride

Cover plate with opening for the installation of a socket with 38 x 38 mm fastening system.

Cover plate VHF, for 1x extension socket, type ASD

Colour		Pack.	Weight	Item No.
Type		pcs	kg/100 pcs.	
VHF-P12	Rape yellow	1	7.400	6109856
PVC Polyvinylchloride				

Cover plate with a \varnothing 45 mm opening for the installation of an extension socket (type ASD-...) with 38 mm fastening track, including 4 screws for fastening the device.

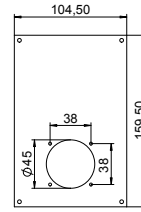

Cover plate VHF, for 2x extension socket, type ASD

Colour		Pack.	Weight	Item No.
Type		pcs	kg/100 pcs.	
VHF-P8	Rape yellow	1	5.900	6109879
PVC Polyvinylchloride				

Cover plate with two \varnothing 45 mm openings for the installation of two extension sockets (type ASD-...) with 38 mm fastening track, including 8 screws for fastening the device.

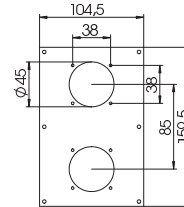

Cover plate VHF, for CEE connection unit

Colour		Pack.	Weight	Item No.
Type		pcs	kg/100 pcs.	
VHF-P3	Rape yellow	1	7.000	6109865
PVC Polyvinylchloride				

Cover plate with a \varnothing 70 mm opening for the installation of 1x CEE socket 16/32 A with 60 mm fastening track, including 4 screws for fastening the device.

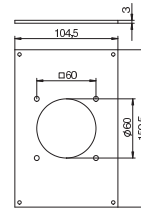

Cover plate VHF, for 1x extension socket, type ASD and 1x CEE connection

Colour		Pack.	Weight	Item No.
Type		pcs	kg/100 pcs.	
VHF-P13	Rape yellow	1	7.400	6109858
PVC Polyvinylchloride				

Cover plate with a \varnothing 45 mm opening for the installation of one extension socket (type ASD-...) with 38 mm fastening track and a \varnothing 60 mm opening for the installation of one CEE socket 16/32 A with 60 mm fastening track, including 8 screws for fastening the device.

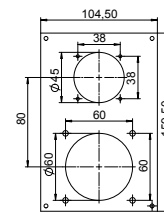

Cover plate VHF for protective equipment installation

Colour		Pack.	Weight	Item No.
Type		pcs	kg/100 pcs.	
VHF-P6	Rape yellow	1	4.700	6109867
PVC Polyvinylchloride				

Cover plate with cut out for the installation of a cover above protection unit (type VHF-AE4TE). Maximum equipment corresponds to four units.

Cover plate for the VHF power supply units for the installation of a cover above protection unit (type VHF-AE4TE). Maximum equipment corresponds to four units.

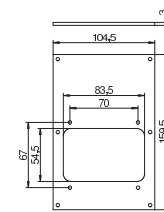

VHF protective unit construction, cover and support clamp

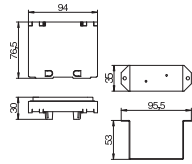

Type

VHF-AE4TE

Cover and support clamp for the installation of protective equipment such as miniature circuit breakers or FI protection switches to max. four units.

Note: Use only in conjunction with the supports VHF-T1 or VHF-T2.

Pack. pcs	Weight		Item No.
	kg/100 pcs.	pcs.	
1	12.800		6109850

VHF protective unit construction, support with PE terminal strip

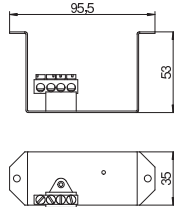

Type

VHF-T1

St Steel

Support with PE terminal strip for installation of FI protection switches, consisting of:

- Base element with hat rail 35 mm and PE terminal strip 4 x 10 mm²
- Fastening material

Pack. pcs	Weight		Item No.
	kg/100 pcs.	pcs.	
1	6.730		6109852

VHF protective unit construction, support with N + PE terminal strip

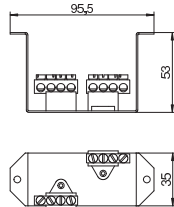

Type

VHF-T2

St Steel

Support with N and PE terminal strip for installation of miniature circuit-breakers, consisting of:

- Base element with hat rail 35 mm, N terminal strip 4 x 10 mm² and PE terminal strip 4 x 10 mm²
- Fastening material

Pack. pcs	Weight		Item No.
	kg/100 pcs.	pcs.	
1	8.380		6109854

Surface-mounted socket 0° with hinged cover, protective contact, single

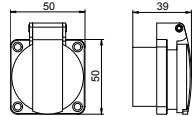

Designation

Colour

Type

ASD-DO SW | prot. contact w. hinged cov. | **Black**

Protective contact extension socket 0° with hinged cover, with screwless terminals, 2-pin, 16 A, 250 V~, with connection terminals to IEC 60884-1. Protection rating: IP44.

Pack. pcs	Weight		Item No.
	kg/100 pcs.	pcs.	
1	1.000		6109873

CEE connection unit, 16 A

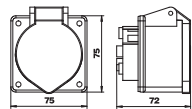

Type

CEE-16A

CEE socket with 60 mm fastening track, 3-pin + N + PE, 400 V, 16 A, 6 h.

Pack. pcs	Weight		Item No.
	kg/100 pcs.	pcs.	
1	19.100		6109874

CEE connection unit, 32 A

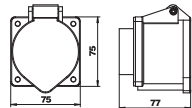

Type

CEE-32A

CEE socket with 60 mm fastening track, 3-pin + N + PE, 400 V, 32 A, 6 h.

Pack. pcs	Weight		Item No.
	kg/100 pcs.	pcs.	
1	20.400		6109876

Tension spring VH/VHF

Type	Designation	Colour	Pack. Weight		Item No.
			pcs	kg/100 pcs.	
VH-F100VA			1	31.000	6109829

V2A Stainless steel, grade 301

Tension spring for VH/VHF power supply units, with German eyelet.

Fmax.= 100 N

L0 = 200 mm

Ln = 500 mm (for Fmax.)

Material: VA ø 3.0 mm



Knotted chain

Type	Designation	Colour	Pack. Weight		Item No.
			m	kg/100 m	
VH-K800	Sold by the metre		1	20.000	6109870

St Steel

Knotted chain made of pre-copper-plated steel, nickel-plated, according to DIN 5686.

Max. tensile force: 800 N.

Note: Specify the required chain length during ordering.

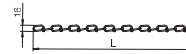

Positioner for VH power supply units

Type	Designation	Colour	Pack. Weight		Item No.
			pcs	kg/100 pcs.	
VH-POS	Up to 6 kg load capacity	Orange	1	80.000	6109887

Positioner for variable height adjustment of a VH power supply unit, support load between 0.5 and 6.0 kg, maximum cable draw-out 1.5 m.

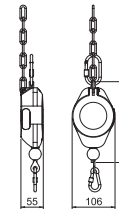

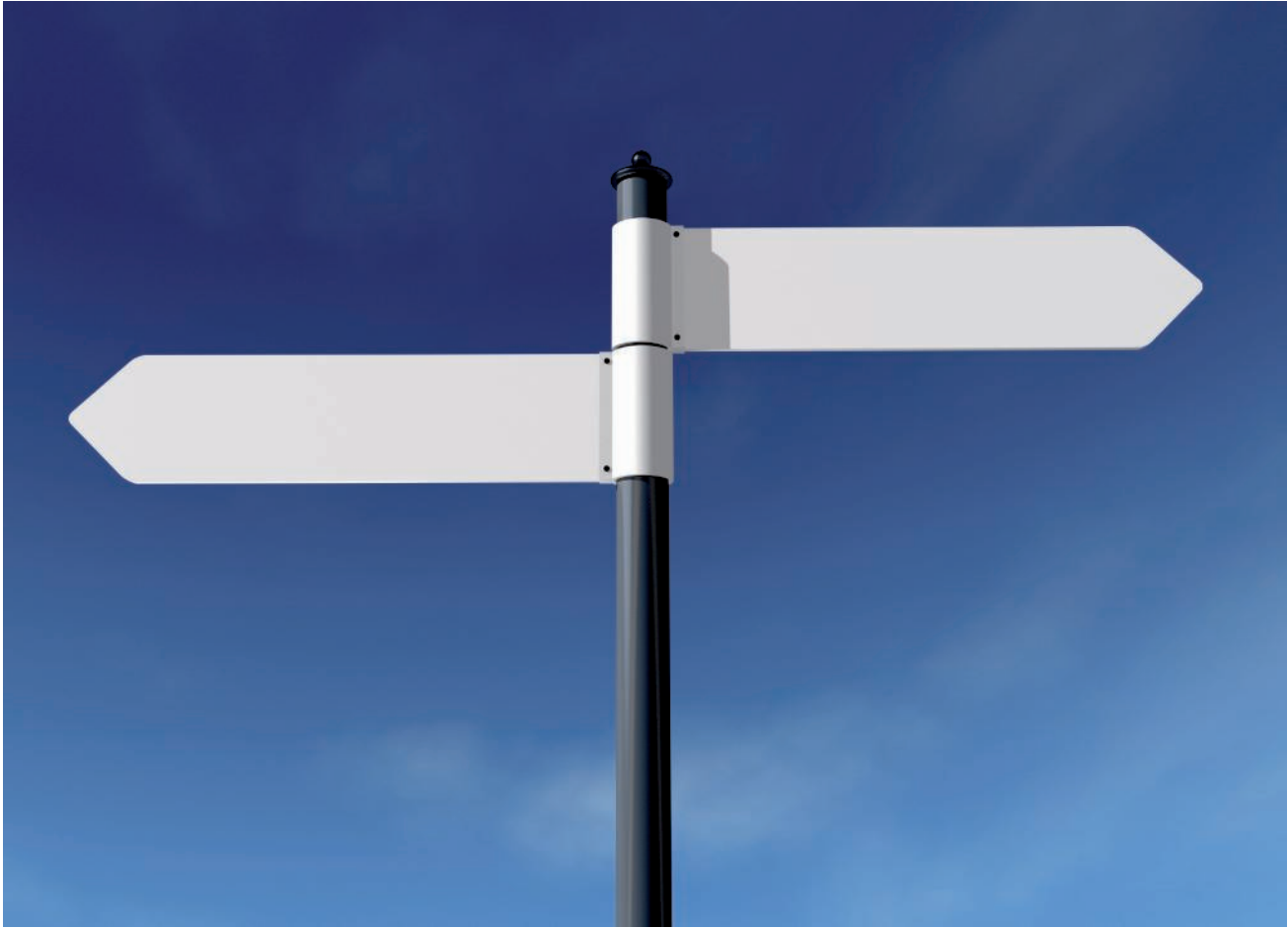

Directories



Numeric directory

126



Type listing

128

GTIN	Art. no.	Page	GTIN	Art. no.	Page	GTIN	Art. no.	Page	GTIN	Art. no.	Page	GTIN	Art. no.	Page
5080886	5092451	28	5900214	6104985	45	5122289	6108010	89	5124832	6108480	75	5714187	6116939	100
	/pc.		5900221	6104988	45	5522997	6108012	90	5124849	6108481	75	5714224	6116942	101
5898023	6104610	44	5900238	6104994	45	5685050	6108013	91	5124856	6108482	75	5714231	6116945	101
5898061	6104613	44	5900245	6104997	45	5523000	6108014	90	5124863	6108483	75	5714248	6116948	101
5898085	6104616	44				5685067	6108015	91	5124894	6108484	75	5714279	6116951	102
5898122	6104622	44	5900283	6105000	45	5523017	6108016	90				5714286	6116954	102
5898139	6104625	44	5900290	6105006	45	6584758	6108024	73	5125037	6109800	114	5714293	6116957	102
5898146	6104628	44	5900306	6105009	45	6584765	6108026	73	6101511	6109801	117	5714309	6116960	102
5898177	6104634	40	5900337	6105012	45	6584796	6108028	73	5125044	6109802	112	6101993	6116961	103
5898191	6104637	40	5900344	6105018	49	5896975	6108045	70	5125075	6109804	112	5714330	6116963	103
5898245	6104640	40	5900351	6105021	49	5273530	6108050	76	5125082	6109806	112	5714347	6116976	103
5898269	6104646	40	5900368	6105024	49	5273547	6108051	76	5125099	6109808	112	5714354	6116979	103
5898313	6104649	40	5900405	6105030	49	5273585	6108052	76	5125105	6109810	114	5714361	6116982	103
5898320	6104652	40	5900412	6105033	49	5273592	6108053	76	5125136	6109812	112	5714392	6116985	103
5898375	6104658	44	5900429	6105036	49	5273608	6108054	76	5125143	6109814	113	5875246	6116986	104
5898436	6104661	44	5900467	6105042	46	5273646	6108055	76	5125150	6109816	113	5714415	6116991	104
5898443	6104664	44	5900474	6105045	46	5273653	6108056	76	5125167	6109818	113	5875468	6116994	106
5898481	6104670	44	5900481	6105048	46	5273660	6108057	76	5125198	6109820	114			
5898498	6104673	44	5900511	6105054	46	6584680	6108060	77	5287391	6109821	114	5438069	6117190	70
5898504	6104676	44	5900528	6105057	46	6584697	6108062	77	5125204	6109822	120	5438090	6117192	70
5898535	6104682	40	5900535	6105060	46	6584703	6108064	78	5125211	6109825	114	5670933	6117196	87
5898542	6104685	40	5900542	6105066	46	6584734	6108066	78	5125228	6109827	120	5670940	6117197	87
5898559	6104688	40	5900559	6105069	46	5273707	6108070	77	6404704	6109829	123	5438113	6117198	70
5898566	6104694	40	5900566	6105072	46	5273714	6108072	77	5125266	6109832	114	5008866	6117200	25
5898573	6104697	40	5900573	6105078	46	6584741	6108074	78	5125273	6109834	115	6235155	6117325	31
5898580	6104700	40	5900580	6105081	46	5273721	6108080	76	6101528	6109835	117	6235216	6117329	31
5898597	6104706	39	5900597	6105084	46	5273769	6108082	77	5125280	6109836	115	6235278	6117337	31
5898603	6104709	39	5900603	6105090	50	5273776	6108084	77	6101559	6109837	117	6235339	6117341	31
5898610	6104712	39	5900641	6105093	50	6584734	6108086	77	5125310	6109838	115	5887515	6117346	32
5898627	6104718	39	5898900	6105096	50	5122326	6108100	74	5428459	6109839	115	5402442	6117347	33
5898634	6104721	39	5898948	6105102	50	5122333	6108101	74	5125327	6109840	115	5887522	6117348	32
5898641	6104724	39	5898962	6105105	50	5122340	6108102	74	6101566	6109841	117	6117499	6117406	51
5898658	6104730	42	5898986	6105108	50	5122388	6108103	74	5125334	6109842	116	5701279	6117407	51
5898665	6104733	42	5899037	6105114	46	5122395	6108104	74	6101573	6109843	117	6214037	6117408	51
5898672	6104736	42	5899075	6105117	46	5122401	6108105	74	5125341	6109850	122	6164813	6117410	51
5898689	6104742	42	5899099	6105120	46	5122449	6108106	74	5125372	6109852	122	6164820	6117411	51
5898696	6104745	42	5899136	6105126	47	5122456	6108107	74	5125389	6109854	122	6164851	6117412	51
5898702	6104748	42	5899143	6105129	47	5122463	6108108	74	6169368	6109856	121	6117550	6117414	51
5898719	6104754	42	5899167	6105132	47	5122500	6108109	74	6169375	6109858	121	5701286	6117415	51
5898726	6104757	42	5899204	6105138	47	5122692	6108125	74	5125396	6109860	120	6215652	6117416	51
5898733	6104760	42	5899228	6105141	47	5122708	6108126	74	5125402	6109861	120	6133833	6117420	51
5898740	6104766	42	5899259	6105144	47	5122746	6108127	74	5125440	6109862	115	6133840	6117421	51
5898757	6104769	42	5899273	6105150	47	5122753	6108128	74	5125501	6109865	121	6133857	6117422	51
5898764	6104772	42	5899457	6105153	47	5122760	6108129	74	5125525	6109867	121	6117611	6117465	27
5898771	6104778	39	5899464	6105156	47	5122807	6108130	74	5125532	6109868	120	6117673	6117473	27
5898788	6104781	39	5899501	6105162	47	5122814	6108131	74						
5898795	6104784	39	5899525	6105165	47	5122821	6108132	74	5125549	6109870	123	5696896	6119202	34
5898849	6104790	39	5899570	6105168	47	5122869	6108133	74				5696902	6119204	34
5898856	6104793	39	5899617	6105174	48	5122876	6108134	74	6169351	6109873	119	5696940	6119206	34
5898863	6104796	39	5899624	6105177	48	5123064	6108150	74	5125594	6109874	119	5696957	6119208	34
5898894	6104802	42	5899686	6105180	48	5123101	6108151	74	5125600	6109876	119	5696964	6119210	34
5898917	6104805	42	5899693	6105186	48	5123118	6108152	74	5477440	6109878	120	5696971	6119212	34
5898924	6104808	42	5899730	6105189	48	5123125	6108153	74	5477457	6109879	121	5696988	6119214	32
5898931	6104814	43	5899747	6105192	48	5123163	6108154	74	6486021	6109887	123	5696995	6119216	32
5898955	6104817	43	5899761	6105198	48	5123170	6108155	74	5125730	6109900	54	5697008	6119218	32
5898979	6104820	43	5899815	6105201	48	5123187	6108156	74	5125747	6109905	54	5697015	6119220	36
5899013	6104826	43	5899822	6105204	48	5123224	6108157	74	5125815	6109932	54	5697022	6119222	36
5899020	6104829	43	5899860	6105210	48	5123231	6108158	74	5125822	6109934	55	5697039	6119224	36
5899044	6104832	43	5899877	6105213	48	5123248	6108159	74	5125860	6109936	55	5697046	6119226	37
5899082	6104838	43	5900009	6105216	48	5123422	6108175	74	5125938	6109950	55	5697053	6119228	37
5899105	6104841	43	5900054	6105222	48	5123453	6108176	74	5125945	6109952	55	5697060	6119230	37
5899150	6104844	43	5900061	6105225	48	5123460	6108177	74				5697077	6119232	36
5899334	6104874	40	5900092	6105228	48	5123477	6108178	74	6485963	6116800	107	5697084	6119234	36
5899341	6104877	40	5900115	6105234	39	5123484	6108179	74	6485970	6116802	107	5697121	6119236	36
5899372	6104880	40	5900177	6105237	39	5123514	6108180	74	6485994	6116804	107	5697138	6119238	34
5899389	6104886	41	5900184	6105240	39	5123521	6108181	74	6485987	6116806	107	5697145	6119240	34
5899396	6104889	41	6102051	6105250	49	5123538	6108182	74	6486007	6116808	108	5697183	6119242	34
5899402	6104892	41	6102068	6105252	49	5123545	6108183	74	6486014	6116810	108	5697190	6119244	34
5899648	6104922	41	6102099	6105254	49	5123552	6108184	74	5875352	6116854	105	5697206	6119246	34
5899709	6104925	41	6											

GTIN	Art. no.	Page	GTIN	Art. no.	Page	GTIN	Art. no.	Page
5887379	6119284	35	6047277	6120044	18	6277995	6154930	109
5887386	6119286	36	6047321	6120046	18			
5887393	6119288	36	6047345	6120048	18	6278350	6154961	109
5887409	6119290	36	6047383	6120050	18	6278411	6154965	109
5887430	6119292	31	6047390	6120052	18	6278473	6154968	109
5887447	6119294	31	6047444	6120072	20	6278657	6154980	109
5887454	6119296	31	6047468	6120074	20	6278718	6154983	109
5888024	6119298	31	6047505	6120076	20			
5887492	6119300	31	6047512	6120078	20	5983330	6288572	62
5887508	6119302	31	6047529	6120080	20	5915027	6288574	64
5925491	6119304	38	6047567	6120082	20	5889106	6288576	63
5925507	6119306	38	6047574	6120102	20	5148715	6288612	59
5925538	6119308	38	6047581	6120104	20	6555543	6288635	65
5889373	6119319	60	6047628	6120106	20			
5888789	6119322	62	6047635	6120108	20	6557516	7404660	82
5888796	6119324	62	6047680	6120110	20	6557523	7404662	82
5888802	6119326	62	6047703	6120112	20	6557554	7404664	82
5888819	6119332	62	6047864	6120122	20	6557561	7404670	83
5888826	6119334	62	6047871	6120124	20	6557578	7404672	83
5888833	6119336	62	6047925	6120126	20	6557585	7404674	83
5896791	6119338	62	6047949	6120128	20	6557615	7404676	83
5896807	6119339	62	6047987	6120130	20	6557622	7404678	83
5896814	6119340	62	6047994	6120132	20	6557646	7404680	83
5888840	6119342	63	6048045	6120152	22	6557639	7404682	83
5888871	6119344	63	6048052	6120154	22	6557677	7404684	84
5888888	6119346	63	6048069	6120155	22	6557684	7404686	84
5888895	6119352	63	6048113	6120158	22	6557691	7404688	84
5888901	6119354	63	6048168	6120160	22			
5888932	6119356	63	6048175	6120162	22	6435289	7408723	85
5888949	6119362	63	6048540	6120222	23	6435265	7408727	85
5888956	6119364	63	6048649	6120224	23			
5888963	6119366	63	6048700	6120226	23			
5888994	6119372	64	6048717	6120228	23			
5889007	6119374	64	6048724	6120230	23			
5889014	6119376	64	6048762	6120232	23			
5889021	6119382	64	6048786	6120242	23			
5889038	6119384	64	6048823	6120244	23			
5889045	6119386	64	6048847	6120246	23			
5983309	6119387	64	6048885	6120248	23			
5983316	6119388	64	6048892	6120250	23			
5983323	6119389	64	6048946	6120252	23			
5889052	6119392	65	6048953	6120262	23			
5889069	6119394	65	6048991	6120264	23			
5889076	6119396	65	6049004	6120266	23			
5889113	6119401	58	6049011	6120268	23			
5889120	6119402	58	6049028	6120270	23			
5889137	6119403	58	6049066	6120272	23			
5889144	6119407	58	6049240	6120302	21			
5889175	6119408	58	6049257	6120304	21			
5889182	6119409	58	6049264	6120306	21			
5889236	6119413	58	6049301	6120312	22			
5889199	6119414	58	6049424	6120322	24			
5889205	6119415	58	6049493	6120324	24			
5889243	6119421	58	6049547	6120326	24			
5889250	6119422	58	6467822	6120746	25			
5889267	6119423	58	6602889	6120797	19			
5889298	6119427	58	6570805	6120920	29			
5889304	6119428	58	6570812	6120922	29			
5889311	6119429	58	6570829	6120924	29			
5889328	6119433	59	6570836	6120926	29			
5889359	6119434	59	6570843	6120928	29			
5889366	6119435	59	6570850	6120930	29			
6609963	6119483	59	6570867	6120932	29			
6609994	6119485	59	6570874	6120934	29			
6410415	6119490	61	6570881	6120936	29			
6410439	6119492	61	6570898	6120938	29			
6439041	6119494	61	6570911	6120940	29			
			6570928	6120942	29			
6049134	6120001	51	6570935	6120950	29			
6049127	6120003	51	6570942	6120952	29			
6049189	6120005	51	6570959	6120954	29			
6046966	6120008	18	6570966	6120960	29			
6046973	6120010	18	6571000	6120962	29			
6047024	6120012	18	6571017	6120964	29			
6047031	6120014	18	6571024	6120966	30			
6047086	6120016	18	6571031	6120968	30			
6047093	6120018	18	6571048	6120970	30			
6047109	6120022	18	6571055	6120980	30			
6047130	6120024	18	6571062	6120982	30			
6047147	6120026	18	6571079	6120984	30			
6047154	6120028	18	6594702	6120992	30			
6047208	6120030	18						
6047222	6120032	18						
6047260	6120042	18	6277575	6154922	109			

EGS_Typ_0A / en / 2019/04/10 12:33:19 (LLExpert_02375) / 2019/04/10 12:33:42 12:33:42



Type	GTIN	Art. no.	Page
71GDCEE	6555543	6288635	65
71GDCEE16	6609963	6119483	59
71GDCEE32	6609994	6119485	59
71MT1 45	5983330	6288572	62
71MT2 45	5889106	6288576	63
71MT2 45	5889106	6288576	68
71MT2 45	5889106	6288576	69
71MT3 45-2	5915027	6288574	64
71MT3 45-2	5915027	6288574	68
71MT3 45-2	5915027	6288574	69
AD-90G M45-1	6594702	6120992	30
ADP-B AL0.5	6215652	6117416	51
ADP-B AL1	6214037	6117408	51
ADP-B RW0.5	6117550	6117414	51
ADP-B RW1	6117499	6117406	51
ADP-B SWGR0.5	5701286	6117415	51
ADP-B SWGR1	5701279	6117407	51
ADP-BF AL0.5	6164851	6117412	51
ADP-BF RW0.5	6164813	6117410	51
ADP-BF SWGR0.5	6164820	6117411	51
ANT-3SD AL1	6164790	6105286	50
ANT-3SD RW1	6164752	6105282	50
ANT-3SD SWGR1	6164769	6105284	50
AR45-BF1 AL	5888833	6119336	62
AR45-BF1 AL	5888833	6119336	71
AR45-BF1 RW	5888819	6119332	62
AR45-BF1 RW	5888819	6119332	71
AR45-BF1 SWGR	5888826	6119334	62
AR45-BF1 SWGR	5888826	6119334	71
AR45-BF2 AL	5888932	6119356	63
AR45-BF2 AL	5888932	6119356	71
AR45-BF2 RW	5888895	6119352	63
AR45-BF2 RW	5888895	6119352	71
AR45-BF2 SWGR	5888901	6119354	63
AR45-BF2 SWGR	5888901	6119354	71
AR45-BF3 AL	5889045	6119386	64
AR45-BF3 AL	5889045	6119386	72
AR45-BF3 RW	5889021	6119382	64
AR45-BF3 RW	5889021	6119382	72
AR45-BF3 SWGR	5889038	6119384	64
AR45-BF3 SWGR	5889038	6119384	72
AR45-BSF1 AL	5896814	6119340	62
AR45-BSF1 AL	5896814	6119340	71
AR45-BSF1 RW	5896791	6119338	62
AR45-BSF1 RW	5896791	6119338	71
AR45-BSF1 SWGR	5896807	6119339	62
AR45-BSF1 SWGR	5896807	6119339	71
AR45-BSF2 AL	5888963	6119366	63
AR45-BSF2 AL	5888963	6119366	72
AR45-BSF2 RW	5888949	6119362	63
AR45-BSF2 RW	5888949	6119362	72
AR45-BSF2 SWGR	5888956	6119364	63
AR45-BSF2 SWGR	5888956	6119364	72
AR45-BSF3 AL	5983323	6119389	64
AR45-BSF3 AL	5983323	6119389	72
AR45-BSF3 RW	5983309	6119387	64
AR45-BSF3 RW	5983309	6119387	72
AR45-BSF3 SWGR	5983316	6119388	64
AR45-BSF3 SWGR	5983316	6119388	72
AR45-F1 AL	5888802	6119326	62
AR45-F1 AL	5888802	6119326	71
AR45-F1 RW	5888789	6119322	62
AR45-F1 RW	5888789	6119322	71
AR45-F1 SWGR	5888796	6119324	62
AR45-F1 SWGR	5888796	6119324	71
AR45-F2 AL	5888888	6119346	63
AR45-F2 AL	5888888	6119346	71
AR45-F2 RW	5888840	6119342	63
AR45-F2 RW	5888840	6119342	71
AR45-F2 SWGR	5888871	6119344	63
AR45-F2 SWGR	5888871	6119344	71
AR45-F3 AL	5889014	6119376	64
AR45-F3 AL	5889014	6119376	72
AR45-F3 RW	5888994	6119372	64
AR45-F3 RW	5888994	6119372	72
AR45-F3 SWGR	5889007	6119374	64
AR45-F3 SWGR	5889007	6119374	72
AR50-F1 AL	5889076	6119396	65

Type	GTIN	Art. no.	Page
AR50-F1 RW	5889052	6119392	65
AR50-F1 SWGR	5889069	6119394	65
ASD-D0 SW	6169351	6109873	119
ASD-D0 SW	6169351	6109873	122
ASM-C5	6235278	6117337	31
ASM-C5 G	6235155	6117325	31
ASM-C5 S	5402442	6117347	33
ASM-C6	6235339	6117341	31
ASM-C6 G	6235216	6117329	31
ASM-C6A	5887522	6117348	32
ASM-C6A	5887522	6117348	119
ASM-C6A G	5887515	6117346	32
ASM-C6A G	5887515	6117346	119
BTA-SKS S1 SW	5438069	6117190	70
BT-F GST18i3p SW	5273585	6108052	76
BT-F GST18i3p SW	5273585	6108052	94
BT-F GST18i3p W	5273592	6108053	76
BT-F GST18i3p W	5273592	6108053	94
BT-S GST18i3p SW	5273653	6108056	76
BT-S GST18i3p SW	5273653	6108056	94
BT-S GST18i3p W	5273660	6108057	76
BT-S GST18i3p W	5273660	6108057	94
BT-S GST18i5p SW	5273714	6108072	77
BT-S GST18i5p SW	5273714	6108072	95
BT-S4 GST18i3 SW	6584703	6108064	78
BT-S4 GST18i3 SW	6584703	6108064	96
BT-S4 GST18i3 W	6584734	6108066	78
BT-S4 GST18i3 W	6584734	6108066	96
CEE-16A	5125594	6109874	119
CEE-16A	5125594	6109874	122
CEE16E2	5148715	6288612	59
CEE-32A	5125600	6109876	119
CEE-32A	5125600	6109876	122
CP45-TP 3SI	6584758	6108024	73
CP45-TP 3SI	6584758	6108024	88
CP45-TP 4SI	6584765	6108026	73
CP45-TP 4SI	6584765	6108026	88
CP45-TP 8C	6584796	6108028	73
CP45-TP 8C	6584796	6108028	88
CST-STD K	6602889	6120797	19
CST-STD K	6602889	6120797	21
CST-STD K	6602889	6120797	22
CST-STD K	6602889	6120797	24
DB-0A3 D22SR2K	5875239	6116918	101
DB-0B3 D1.4S	5714279	6116951	102
DB-0B3 D1.4S2K	5714293	6116957	102
DB-0B3 D3S	5714187	6116939	100
DB-0B3 D3S2K	5714231	6116945	101
DB-1B3 D1.4S	5714248	6116948	101
DB-1B3 D1.4S2K	5714286	6116954	102
DB-1B3 D3S	5714170	6116936	100
DB-1B3 D3S2K	5714224	6116942	101
DB-5A3 D3S	5714156	6116930	100
DB-5A3 D3S2K	5714163	6116933	100
DBK2-D3 D2S2K	6485970	6116802	107
DBK2-D4 D3S2K	6485987	6116806	107
DBK2-E3 D3S	6485963	6116800	107
DBK2-E4 D4S	6485994	6116804	107
DBK2-M4H D2S2K	6486014	6116810	108
DBK2-M5V D3S2K	6486007	6116808	108
DB-M0B3 D3S2K	5714330	6116963	103
DB-M1B3 D3S2K	5714309	6116960	102
DB-MH1B3 D3S2K	6101993	6116961	103
DBV-A3A D2S	5875352	6116854	105
DBV-A3A D2S2K	5875390	6116870	105
DBV-A3A D3S	5875376	6116862	105
DBV-A3A D3S2K	5875420	6116878	106
DBV-A3E D2S	5875369	6116858	105

Type	GTIN	Art. no.	Page
DBV-A3E D2S2K	5875413	6116874	105
DBV-A3E D3S	5875383	6116866	105
DBV-A3E D3S2K	5875437	6116882	106
DBV-MA3A D3S2K	5875444	6116886	106
DBV-MA3E D3S2K	5875451	6116890	106
DBV-MHA3A D2S2K	6102006	6116887	106
DBV-MHA3E D2S2K	6102037	6116888	106
DBZ-BFE	5714361	6116982	103
DBZ-BST	5714392	6116985	103
DBZ-BSUT	5875246	6116986	104
DBZ-BZ40	5714347	6116976	103
DBZ-BZ75	5714354	6116979	103
DBZ-FLKB	5714415	6116991	104
DBZ-LS	5875468	6116994	106
DTE-RW G2A1	6439041	6119494	61
DTE-RW G2C1	6410439	6119492	61
DTE-RW G2RM1	6410415	6119490	61
DTG-02C AL1	5887379	6119284	35
DTG-02C RW1	5887331	6119280	35
DTG-02C SWGR1	5887348	6119282	35
DTG-02LE AL1	5925538	6119308	38
DTG-02LE RW1	5925491	6119304	38
DTG-02LE SWGR1	5925507	6119306	38
DTG-2A AL1	5696940	6119206	34
DTG-2A RW1	5696896	6119202	34
DTG-2A SWGR1	5696902	6119204	34
DTG-2B AL1	5696971	6119212	34
DTG-2B RW1	5696957	6119208	34
DTG-2B SWGR1	5696964	6119210	34
DTG-2C AL1	5697008	6119218	32
DTG-2C AL1	5697008	6119218	35
DTG-2C RW1	5696988	6119214	32
DTG-2C RW1	5696988	6119214	35
DTG-2C SWGR1	5696995	6119216	32
DTG-2C SWGR1	5696995	6119216	35
DTG-2EP AL1	5697121	6119236	36
DTG-2EP RW1	5697077	6119232	36
DTG-2EP SWGR1	5697084	6119234	36
DTG-2F AL1	5697039	6119224	36
DTG-2F RW1	5697015	6119220	36
DTG-2F SWGR1	5697022	6119222	36
DTG-2PA AL1	5697060	6119230	37
DTG-2PA RW1	5697046	6119226	37
DTG-2PA SWGR1	5697053	6119228	37
DTG-2RM AL1	5887454	6119296	31
DTG-2RM AL1	5887454	6119296	37
DTG-2RM RW1	5887430	6119292	31
DTG-2RM RW1	5887430	6119292	37
DTG-2RM SWGR1	5887447	6119294	31
DTG-2RM SWGR1	5887447	6119294	37
DTS-02C AL1	5887409	6119290	36
DTS-02C RW1	5887386	6119286	36
DTS-02C SWGR1	5887393	6119288	36
DTS-2A AL1	5697183	6119242	34
DTS-2A RW1	5697138	6119238	34
DTS-2A SWGR1	5697145	6119240	34
DTS-2B AL1	5697244	6119248	34
DTS-2B RW1	5697190	6119244	34
DTS-2B SWGR1	5697206	6119246	34
DTS-2C AL1	5697305	6119254	32
DTS-2C AL1	5697305	6119254	35
DTS-2C RW1	5697251	6119250	32
DTS-2C RW1	5697251	6119250	35
DTS-2C RW1	5697251	6119250	118
DTS-2C SWGR1	5697268	6119252	32
DTS-2C SWGR1	5697268	6119252	35
DTS-2EP AL1	5697497	6119272	36
DTS-2EP RW1	5697442	6119268	36
DTS-2EP SWGR1	5697480	6119270	36
DTS-2F AL1	5697374	6119260	37
DTS-2F RW1	5697312	6119256	37
DTS-2F SWGR1	5697329	6119258	37
DTS-2PA AL1	5697435	6119266	37
DTS-2PA RW1	5697381	6119262	37
DTS-2PA SWGR1	5697428	6119264	37
DTS-2RM AL1	5887508	6119302	31
DTS-2RM AL1	5887508	6119302	38
DTS-2RM RW1	5888024	6119298	31
DTS-2RM RW1	5888024	6119298	38
DTS-2RM SWGR1	5887492	6119300	31

Type	GTIN	Art. no.	Page
DTS-2RM SWGR1	5887492	6119300	38
FLK-2K LGR	6277575	6154922	109
FLK-2K SWGR	6277995	6154930	109
FLK-BEF	6278473	6154968	109
FLK-BS1	6278657	6154980	109
FLK-BS2	6278718	6154983	109
FLK-HL ZL	6278350	6154961	109
FLK-TAZ	6278411	6154965	109
IKR-6 RW	5889373	6119319	60
KAL-K11 AL1	6133857	6117422	51
KAL-K11 RW1	6133833	6117420	51
KAL-K11 SWGR1	6133840	6117421	51
MTG-12R F AL1	5899747	6105192	48
MTG-12R F RW1	5899693	6105186	48
MTG-12R F SWGR1	5899730	6105189	48
MTG-12R L AL1	5899570	6105168	47
MTG-12R L RW1	5899501	6105162	47
MTG-12R L SWGR1	5899525	6105165	47
MTG-2BC F AL1	5898900	6105096	50
MTG-2BC F RW1	5900603	6105090	50
MTG-2BC F SWGR1	5900641	6105093	50
MTG-2R F AL1	5900566	6105072	46
MTG-2R F RW1	5900542	6105066	46
MTG-2R F SWGR1	5900559	6105069	46
MTG-2R L AL1	5900481	6105048	46
MTG-2R L RW1	5900467	6105042	46
MTG-2R L SWGR1	5900474	6105045	46
MTG-2UC2.1 AL1	6594665	6105304	26
MTG-2UC2.1 RW1	6594603	6105300	26
MTG-2UC2.1 SWGR1	6594641	6105302	26
MTG-3R F AL1	5899259	6105144	47
MTG-3R F RW1	5899204	6105138	47
MTG-3R F SWGR1	5899228	6105141	47
MTG-3R L AL1	5899099	6105120	46
MTG-3R L RW1	5899037	6105114	46
MTG-3R L SWGR1	5899075	6105117	46
MTG-BC F AL1	5900368	6105024	49
MTG-BC F RW1	5900344	6105018	49
MTG-BC F SWGR1	5900351	6105021	49
MTG-DB O AL1	5898610	6104712	39
MTG-DB O RW1	5898597	6104706	39
MTG-DB O SWGR1	5898603	6104709	39
MTG-DB9 F AL1	5898559	6104688	40
MTG-DB9 F RW1	5898535	6104682	40
MTG-DB9 F SWGR1	5898542	6104685	40
MTG-DB9 S AL1	5898245	6104640	40
MTG-DB9 S RW1	5898177	6104634	40
MTG-DB9 S SWGR1	5898191	6104637	40
MTG-DV O AL1	5898795	6104784	39
MTG-DV O RW1	5898771	6104778	39
MTG-DV O SWGR1	5898788	6104781	39
MTG-DVI F AL1	5898733	6104760	42
MTG-DVI F RW1	5898719	6104754	42
MTG-DVI F SWGR1	5898726	6104757	42
MTG-DVI S AL1	5898672	6104736	42
MTG-DVI S RW1	5898658	6104730	42
MTG-DVI S SWGR1	5898665	6104733	42
MTG-HD F AL1	5899044	6104832	43
MTG-HD F RW1	5899013	6104826	43
MTG-HD F SWGR1	5899020	6104829	43
MTG-HD S AL1	5898924	6104808	42
MTG-HD S RW1	5898894	6104802	42
MTG-HD S SWGR1	5898917	6104805	42
MTG-MK L AL1	5899945	6104952	44
MTG-MK L RW1	5899921	6104946	44
MTG-MK L SWGR1	5899938	6104949	44
MTG-R F AL1	5900283	6105000	45
MTG-R F RW1	5900238	6104994	45
MTG-R F SWGR1	5900245	6104997	45
MTG-R L AL1	5900122	6104976	45
MTG-R L RW1	5900047	6104970	45
MTG-R L SWGR1	5900108	6104973	45
MTG-SON S AL1	6102174	6105274	49
MTG-SON S RW1	6102150	6105270	49
MTG-SON S SWGR1	6102167	6105272	49
MTG-U3A F AL1	5899754	6104928	41
MTG-U3A F RW1	5899648	6104922	41
MTG-U3A F SWGR1	5899709	6104925	41

Type	GTIN	Art. no.	Page
MTG-U3A S AL1	5899372	6104880	40
MTG-U3A S RW1	5899334	6104874	40
MTG-U3A S SWGR1	5899341	6104877	40
MTG-VGA F AL1	5898443	6104664	44
MTG-VGA F RW1	5898375	6104658	44
MTG-VGA F SWGR1	5898436	6104661	44
MTG-VGA S AL1	5898085	6104616	44
MTG-VGA S RW1	5898023	6104610	44
MTG-VGA S SWGR1	5898061	6104613	44
MTG-X O AL1	5900184	6105240	39
MTG-X O RW1	5900115	6105234	39
MTG-X O SWGR1	5900177	6105237	39
MTG-X3F L AL1	5900009	6105216	48
MTG-X3F L RW1	5899860	6105210	48
MTG-X3F L SWGR1	5899877	6105213	48
MTG-X3F S AL1	6102099	6105254	49
MTG-X3F S RW1	6102051	6105250	49
MTG-X3F S SWGR1	6102068	6105252	49
MTG-X3M L AL1	5900092	6105228	48
MTG-X3M L RW1	5900054	6105222	48
MTG-X3M L SWGR1	5900061	6105225	48
MTG-X3M S AL1	6102129	6105262	49
MTG-X3M S RW1	6102105	6105258	49
MTG-X3M S SWGR1	6102112	6105260	49
MTS-12R F AL1	5899822	6105204	48
MTS-12R F RW1	5899761	6105198	48
MTS-12R F SWGR1	5899815	6105201	48
MTS-12R L AL1	5899686	6105180	48
MTS-12R L RW1	5899617	6105174	48
MTS-12R L SWGR1	5899624	6105177	48
MTS-2BC F AL1	5898986	6105108	50
MTS-2BC F RW1	5898948	6105102	50
MTS-2BC F SWGR1	5898962	6105105	50
MTS-2R F AL1	5900597	6105084	46
MTS-2R F RW1	5900573	6105078	46
MTS-2R F SWGR1	5900580	6105081	46
MTS-2R L AL1	5900535	6105060	46
MTS-2R L RW1	5900511	6105054	46
MTS-2R L SWGR1	5900528	6105057	46
MTS-3R F AL1	5899464	6105156	47
MTS-3R F RW1	5899273	6105150	47
MTS-3R F SWGR1	5899457	6105153	47
MTS-3R L AL1	5899167	6105132	47
MTS-3R L RW1	5899136	6105126	47
MTS-3R L SWGR1	5899143	6105129	47
MTS-BC F AL1	5900429	6105036	49
MTS-BC F RW1	5900405	6105030	49
MTS-BC F SWGR1	5900412	6105033	49
MTS-DB O AL1	5898641	6104724	39
MTS-DB O RW1	5898627	6104718	39
MTS-DB O SWGR1	5898634	6104721	39
MTS-DB9 F AL1	5898580	6104700	40
MTS-DB9 F RW1	5898566	6104694	40
MTS-DB9 F SWGR1	5898573	6104697	40
MTS-DB9 S AL1	5898320	6104652	40
MTS-DB9 S RW1	5898269	6104646	40
MTS-DB9 S SWGR1	5898313	6104649	40
MTS-DV O AL1	5898863	6104796	39
MTS-DV O RW1	5898849	6104790	39
MTS-DV O SWGR1	5898856	6104793	39
MTS-DVI F AL1	5898764	6104772	42
MTS-DVI F RW1	5898740	6104766	42
MTS-DVI F SWGR1	5898757	6104769	42
MTS-DVI S AL1	5898702	6104748	42
MTS-DVI S RW1	5898689	6104742	42
MTS-DVI S SWGR1	5898696	6104745	42
MTS-HD F AL1	5899150	6104844	43
MTS-HD F RW1	5899082	6104838	43
MTS-HD F SWGR1	5899105	6104841	43
MTS-HD S AL1	5898979	6104820	43
MTS-HD S RW1	5898931	6104814	43
MTS-HD S SWGR1	5898955	6104817	43
MTS-MK L AL1	5899990	6104964	45
MTS-MK L RW1	5899976	6104958	45
MTS-MK L SWGR1	5899983	6104961	45
MTS-R F AL1	5900337	6105012	45
MTS-R F RW1	5900290	6105006	45
MTS-R F SWGR1	5900306	6105009	45
MTS-R L AL1	5900221	6104988	45
MTS-R L RW1	5900160	6104982	45
MTS-R L SWGR1	5900214	6104985	45
MTS-U3A F AL1	5899884	6104940	41
MTS-U3A F RW1	5899808	6104934	41

Type	GTIN	Art. no.	Page
MTS-U3A F SWGR1	5899853	6104937	41
MTS-U3A S AL1	5899402	6104892	41
MTS-U3A S RW1	5899389	6104886	41
MTS-U3A S SWGR1	5899396	6104889	41
MTS-VGA F AL1	5898504	6104676	44
MTS-VGA F RW1	5898481	6104670	44
MTS-VGA F SWGR1	5898498	6104673	44
MTS-VGA S AL1	5898146	6104628	44
MTS-VGA S RW1	5898122	6104622	44
MTS-VGA S SWGR1	5898139	6104625	44
PAD-ID6 AL1	6049189	6120005	51
PAD-ID6 RW1	6049127	6120003	51
PAD-ID6 SWGR1	6049134	6120001	51
RS-BS AL1	6570959	6120954	29
RS-BS RW1	6570935	6120950	29
RS-BS SWGR1	6570942	6120952	29
RT-BS AL1	6571079	6120984	30
RT-BS RW1	6571055	6120980	30
RT-BS SWGR1	6571062	6120982	30
SDE-RW D0GN1	5889120	6119402	58
SDE-RW D0GN1B	5889250	6119422	58
SDE-RW D0GN2	5889175	6119408	58
SDE-RW D0GN2B	5889304	6119428	58
SDE-RW D0GN3	5889205	6119415	58
SDE-RW D0GN3B	5889359	6119434	59
SDE-RW D0RT1	5889137	6119403	58
SDE-RW D0RT1B	5889267	6119423	58
SDE-RW D0RT2	5889182	6119409	58
SDE-RW D0RT2B	5889311	6119429	58
SDE-RW D0RT3	5889236	6119413	58
SDE-RW D0RT3B	5889366	6119435	59
SDE-RW D0RW1	5889113	6119401	58
SDE-RW D0RW1B	5889243	6119421	58
SDE-RW D0RW2	5889144	6119407	58
SDE-RW D0RW2B	5889298	6119427	58
SDE-RW D0RW3	5889199	6119414	58
SDE-RW D0RW3B	5889328	6119433	59
SKS-CH0 RW1	5008866	6117200	25
SKS-CH0 RW1	5008866	6117200	118
STA-SKS S1 SW	5438090	6117192	70
STA-SKS SU1 SW	5670933	6117196	87
STA-SKS SU1 W	5670940	6117197	87
STD-D0 AL1	6047093	6120018	18
STD-D0 AL2	6047222	6120032	18
STD-D0 AL3	6047390	6120052	18
STD-D0 MZGN1	6047024	6120012	18
STD-D0 MZGN2	6047147	6120026	18
STD-D0 MZGN3	6047321	6120046	18
STD-D0 R0R1	6046973	6120010	18
STD-D0 R0R2	6047130	6120024	18
STD-D0 R0R3	6047277	6120044	18
STD-D0 RW1	6046966	6120008	18
STD-D0 RW1	6046966	6120008	118
STD-D0 RW2	6047109	6120022	18
STD-D0 RW3	6047260	6120042	18
STD-D0 SRO1	6047031	6120014	18
STD-D0 SRO2	6047154	6120028	18
STD-D0 SRO3	6047345	6120048	18
STD-D0 SWGR1	6047086	6120016	18
STD-D0 SWGR2	6047208	6120030	18
STD-D0 SWGR3	6047383	6120050	18
STD-D3 AL1	6047567	6120082	20
STD-D3 AL2	6047703	6120112	20
STD-D3 AL3	6047994	6120132	20
STD-D3 MZGN1	6047505	6120076	20
STD-D3 MZGN2	6047628	6120106	20
STD-D3 MZGN3	6047925	6120126	20
STD-D3 R0R1	6047468	6120074	20
STD-D3 R0R2	6047581	6120104	20
STD-D3 R0R3	6047871	6120124	20
STD-D3 RW1	6047444	6120072	20
STD-D3 RW2	6047574	6120102	20
STD-D3 RW2	6047574	6120102	118
STD-D3 RW3	6047864	6120122	20
STD-D3 SRO1	6047512	6120078	20
STD-D3 SRO2	6047635	6120108	20
STD-D3 SRO3	6047949	6120128	20

Type	GTIN	Art. no.	Page	Type	GTIN	Art. no.	Page
STD-D3 SWGR1	6047529	6120080	20	UTC4 G W3OR1 Ü	6557684	7404686	84
STD-D3 SWGR2	6047680	6120110	20	UTC4 G W4	6557639	7404682	83
STD-D3 SWGR3	6047987	6120130	20				
STD-D3K SRO1	6049240	6120302	21	UVS-6S2	5122265	6108000	89
STD-D3K SRO2	6049257	6120304	21	UVS-6S2SA	5522997	6108012	90
STD-D3K SRO3	6049264	6120306	21	UVS-6S2SA1P	5685050	6108013	91
STD-F0 AL1	6048175	6120162	22	UVS-6S6W2	5122289	6108010	89
STD-F0 MZGN1	6048069	6120155	22	UVS-6S6W2SA	5523017	6108016	90
STD-F0 ROR1	6048052	6120154	22	UVS-6W2	5122272	6108005	89
STD-F0 RW1	6048045	6120152	22	UVS-6W2SA	5523000	6108014	90
STD-F0 RW1	6048045	6120152	118	UVS-6W2SA1P	5685067	6108015	91
STD-F0 SRO1	6048113	6120158	22				
STD-F0 SWGR1	6048168	6120160	22	VB-2 GST18i3p	6584673	6108086	77
STD-F0K SRO1	6049301	6120312	22	VB-2 GST18i3p	6584673	6108086	95
STD-F3 AL1	6048762	6120232	23				
STD-F3 AL2	6048946	6120252	23	VB-3 GST18i3p	5273721	6108080	76
STD-F3 AL3	6049066	6120272	23	VB-3 GST18i3p	5273721	6108080	95
STD-F3 MZGN1	6048700	6120226	23				
STD-F3 MZGN2	6048847	6120246	23	VB-5 GST18i3p	5273769	6108082	77
STD-F3 MZGN3	6049004	6120266	23	VB-5 GST18i3p	5273769	6108082	95
STD-F3 ROR1	6048649	6120224	23				
STD-F3 ROR2	6048823	6120244	23	VB-G GST18i3p	5896975	6108045	70
STD-F3 ROR3	6048991	6120264	23				
STD-F3 RW1	6048540	6120222	23	VB-SKS S	5438113	6117198	70
STD-F3 RW2	6048786	6120242	23	VB-SKS S	5438113	6117198	87
STD-F3 RW2	6048786	6120242	118				
STD-F3 RW3	6048953	6120262	23	VB-T GST18i3p	5273776	6108084	77
STD-F3 SRO1	6048717	6120228	23	VB-T GST18i3p	5273776	6108084	95
STD-F3 SRO2	6048885	6120248	23				
STD-F3 SRO3	6049011	6120268	23	VH-4 3SD1C16	5125075	6109804	112
STD-F3 SWGR1	6048724	6120230	23	VH-4 3SF1C16	5125099	6109808	112
STD-F3 SWGR2	6048892	6120250	23	VH-4 4SD	5125044	6109802	112
STD-F3 SWGR3	6049028	6120270	23	VH-4 4SF	5125082	6109806	112
STD-F3K SRO1	6049424	6120322	24	VH-4 LG	5125037	6109800	114
STD-F3K SRO2	6049493	6120324	24	VH-4 LG RW	6101511	6109801	117
STD-F3K SRO3	6049547	6120326	24	VH-4 TW	5125266	6109832	114
STD-IT0 RW0.5	6467822	6120746	25	VH-4 TW	5125266	6109832	117
				VH-4L 3SD1C16	5125143	6109814	113
ST-F GST18i3p SW	5273530	6108050	76	VH-4L 4SD	5125167	6109818	113
ST-F GST18i3p SW	5273530	6108050	94	VH-4L 4SD	5125136	6109812	112
ST-F GST18i3p W	5273547	6108051	76	VH-4L 4SF	5125150	6109816	113
ST-F GST18i3p W	5273547	6108051	94	VH-4L LG	5125105	6109810	114
				VH-8 LG	5287391	6109821	114
ST-S GST18i3p SW	5273608	6108054	76	VH-8 LG8P2	5125198	6109820	114
ST-S GST18i3p SW	5273608	6108054	94	VH-8 TW	5125440	6109862	115
ST-S GST18i3p W	5273646	6108055	76	VH-8L LG	5125211	6109825	114
ST-S GST18i3p W	5273646	6108055	94				
ST-S GST18i5p SW	5273707	6108070	77	VH-F100VA	6404704	6109829	123
ST-S GST18i5p SW	5273707	6108070	95				
ST-S4 GST18i3 SW	6584680	6108060	77	VHF-8 LG	5125204	6109822	120
ST-S4 GST18i3 SW	6584680	6108060	95	VHF-8L LG	5125228	6109827	120
ST-S4 GST18i3 W	6584697	6108062	77	VHF-AE4TE	5125341	6109850	122
ST-S4 GST18i3 W	6584697	6108062	95	VHF-P1	5125532	6109868	120
				VHF-P12	6169368	6109856	121
TA-WB AL0.5	6571017	6120964	29	VHF-P13	6169375	6109858	121
TA-WB AL1	6571048	6120970	30	VHF-P3	5125501	6109865	121
TA-WB RW0.5	6570966	6120960	29	VHF-P6	5125525	6109867	121
TA-WB RW1	6571024	6120966	30	VHF-P7	5477440	6109878	120
TA-WB SWGR0.5	6571000	6120962	29	VHF-P8	5477457	6109879	121
TA-WB SWGR1	6571031	6120968	30	VHF-T1	5125372	6109852	122
				VHF-T2	5125389	6109854	122
ÜSM-A	5080886	5092451	28	VHF-TW	5125396	6109860	120
				VHF-TW L	5125402	6109861	120
ÜSS 45-A-RW	6117611	6117465	27				
ÜSS 45-O-RW	6117673	6117473	27				
				VH-K800	5125549	6109870	123
UT3 45 3	6435289	7408723	85				
UT3 45 3	6435289	7408723	86				
UT4 45 4	6435265	7408727	85	VH-P1	5125334	6109842	116
UT4 45 4	6435265	7408727	86	VH-P1 RW	6101573	6109843	117
				VH-P2	5125273	6109834	115
UTC3 G W2	6557523	7404662	82	VH-P3	5125310	6109838	115
UTC3 G W2OR1	6557516	7404660	82	VH-P3 RW	6101559	6109837	117
UTC3 G W3	6557554	7404664	82	VH-P4	5125327	6109840	115
				VH-P4 RW	6101566	6109841	117
UTC4 G OR2	6557561	7404670	83	VH-P5	5125280	6109836	115
UTC4 G OR2GN1	6557691	7404688	84	VH-P5 RW	6101528	6109835	117
UTC4 G OR4	6557578	7404672	83	VH-P7	5428459	6109839	115
UTC4 G W2	6557585	7404674	83	VH-POS	6486021	6109887	123
UTC4 G W2OR2	6557615	7404676	83				
UTC4 G W2OR2 Ü	6557622	7404678	83	VL-3Q1.5 1 SW	5122326	6108100	74
UTC4 G W3	6557646	7404680	83	VL-3Q1.5 1 SW	5122326	6108100	92
UTC4 G W3OR1	6557677	7404684	84	VL-3Q1.5 1 W	5122692	6108125	74

Type	GTIN	Art. no.	Page
VL-3Q1.5 1 W	5122692	6108125	92
VL-3Q1.5 10 SW	5122500	6108109	74
VL-3Q1.5 10 SW	5122500	6108109	92
VL-3Q1.5 10 W	5122876	6108134	74
VL-3Q1.5 10 W	5122876	6108134	92
VL-3Q1.5 2 SW	5122333	6108101	74
VL-3Q1.5 2 SW	5122333	6108101	92
VL-3Q1.5 2 W	5122708	6108126	74
VL-3Q1.5 2 W	5122708	6108126	92
VL-3Q1.5 3 SW	5122340	6108102	74
VL-3Q1.5 3 SW	5122340	6108102	92
VL-3Q1.5 3 W	5122746	6108127	74
VL-3Q1.5 3 W	5122746	6108127	92
VL-3Q1.5 4 SW	5122388	6108103	74
VL-3Q1.5 4 SW	5122388	6108103	92
VL-3Q1.5 4 W	5122753	6108128	74
VL-3Q1.5 4 W	5122753	6108128	92
VL-3Q1.5 5 SW	5122395	6108104	74
VL-3Q1.5 5 SW	5122395	6108104	92
VL-3Q1.5 5 W	5122760	6108129	74
VL-3Q1.5 5 W	5122760	6108129	92
VL-3Q1.5 6 SW	5122401	6108105	74
VL-3Q1.5 6 SW	5122401	6108105	92
VL-3Q1.5 6 W	5122807	6108130	74
VL-3Q1.5 6 W	5122807	6108130	92
VL-3Q1.5 7 SW	5122449	6108106	74
VL-3Q1.5 7 SW	5122449	6108106	92
VL-3Q1.5 7 W	5122814	6108131	74
VL-3Q1.5 7 W	5122814	6108131	92
VL-3Q1.5 8 SW	5122456	6108107	74
VL-3Q1.5 8 SW	5122456	6108107	92
VL-3Q1.5 8 W	5122821	6108132	74
VL-3Q1.5 8 W	5122821	6108132	92
VL-3Q1.5 9 SW	5122463	6108108	74
VL-3Q1.5 9 SW	5122463	6108108	92
VL-3Q1.5 9 W	5122869	6108133	74
VL-3Q1.5 9 W	5122869	6108133	92
VL-3Q2.5 1 SW	5123064	6108150	74
VL-3Q2.5 1 SW	5123064	6108150	93
VL-3Q2.5 1 W	5123422	6108175	74
VL-3Q2.5 1 W	5123422	6108175	93
VL-3Q2.5 10 SW	5123248	6108159	74
VL-3Q2.5 10 SW	5123248	6108159	93
VL-3Q2.5 10 W	5123552	6108184	74
VL-3Q2.5 10 W	5123552	6108184	93
VL-3Q2.5 2 SW	5123101	6108151	74
VL-3Q2.5 2 SW	5123101	6108151	93
VL-3Q2.5 2 W	5123453	6108176	74
VL-3Q2.5 2 W	5123453	6108176	93
VL-3Q2.5 3 SW	5123118	6108152	74
VL-3Q2.5 3 SW	5123118	6108152	93
VL-3Q2.5 3 W	5123460	6108177	74
VL-3Q2.5 3 W	5123460	6108177	93
VL-3Q2.5 4 SW	5123125	6108153	74
VL-3Q2.5 4 SW	5123125	6108153	93
VL-3Q2.5 4 W	5123477	6108178	74
VL-3Q2.5 4 W	5123477	6108178	93
VL-3Q2.5 5 SW	5123163	6108154	74
VL-3Q2.5 5 SW	5123163	6108154	93
VL-3Q2.5 5 W	5123484	6108179	74
VL-3Q2.5 5 W	5123484	6108179	93
VL-3Q2.5 6 SW	5123170	6108155	74
VL-3Q2.5 6 SW	5123170	6108155	93
VL-3Q2.5 6 W	5123514	6108180	74
VL-3Q2.5 6 W	5123514	6108180	93
VL-3Q2.5 7 SW	5123187	6108156	74
VL-3Q2.5 7 SW	5123187	6108156	93
VL-3Q2.5 7 W	5123521	6108181	74
VL-3Q2.5 7 W	5123521	6108181	93
VL-3Q2.5 8 SW	5123224	6108157	74
VL-3Q2.5 8 SW	5123224	6108157	93
VL-3Q2.5 8 W	5123538	6108182	74
VL-3Q2.5 8 W	5123538	6108182	93
VL-3Q2.5 9 SW	5123231	6108158	74
VL-3Q2.5 9 SW	5123231	6108158	93
VL-3Q2.5 9 W	5123545	6108183	74
VL-3Q2.5 9 W	5123545	6108183	93
VL-3Q2.5 H1 SW	5124368	6108450	75
VL-3Q2.5 H1 SW	5124368	6108450	92
VL-3Q2.5 H1 W	5124733	6108475	75
VL-3Q2.5 H1 W	5124733	6108475	92
VL-3Q2.5 H10 SW	5124542	6108459	75
VL-3Q2.5 H10 SW	5124542	6108459	92
VL-3Q2.5 H10 W	5124894	6108484	75

Type	GTIN	Art. no.	Page
VL-3Q2.5 H10 W	5124894	6108484	92
VL-3Q2.5 H2 SW	5124375	6108451	75
VL-3Q2.5 H2 SW	5124375	6108451	92
VL-3Q2.5 H2 W	5124740	6108476	75
VL-3Q2.5 H2 W	5124740	6108476	92
VL-3Q2.5 H3 SW	5124382	6108452	75
VL-3Q2.5 H3 SW	5124382	6108452	92
VL-3Q2.5 H3 W	5124788	6108477	75
VL-3Q2.5 H3 W	5124788	6108477	92
VL-3Q2.5 H4 SW	5124429	6108453	75
VL-3Q2.5 H4 SW	5124429	6108453	92
VL-3Q2.5 H4 W	5124795	6108478	75
VL-3Q2.5 H4 W	5124795	6108478	92
VL-3Q2.5 H5 SW	5124436	6108454	75
VL-3Q2.5 H5 SW	5124436	6108454	92
VL-3Q2.5 H5 W	5124801	6108479	75
VL-3Q2.5 H5 W	5124801	6108479	92
VL-3Q2.5 H6 SW	5124443	6108455	75
VL-3Q2.5 H6 SW	5124443	6108455	92
VL-3Q2.5 H6 W	5124832	6108480	75
VL-3Q2.5 H6 W	5124832	6108480	92
VL-3Q2.5 H7 SW	5124481	6108456	75
VL-3Q2.5 H7 SW	5124481	6108456	92
VL-3Q2.5 H7 W	5124849	6108481	75
VL-3Q2.5 H7 W	5124849	6108481	92
VL-3Q2.5 H8 SW	5124498	6108457	75
VL-3Q2.5 H8 SW	5124498	6108457	92
VL-3Q2.5 H8 W	5124856	6108482	75
VL-3Q2.5 H8 W	5124856	6108482	92
VL-3Q2.5 H9 SW	5124504	6108458	75
VL-3Q2.5 H9 SW	5124504	6108458	92
VL-3Q2.5 H9 W	5124863	6108483	75
VL-3Q2.5 H9 W	5124863	6108483	92
VR-GST18	6584741	6108074	78
VR-GST18	6584741	6108074	94
WG-AF2TE RW	5125815	6109932	54
WG-AK RW	5125730	6109900	54
WG-MK RW	5125747	6109905	54
WG-UBR2 RW	5125822	6109934	55
WG-UBR3 RW	5125860	6109936	55
WG-UK2	5125938	6109950	55
WG-UK3	5125945	6109952	55
WS-UB AL0.5	6570829	6120924	29
WS-UB AL1	6570881	6120936	29
WS-UB RW0.5	6570805	6120920	29
WS-UB RW1	6570867	6120932	29
WS-UB SWGR0.5	6570812	6120922	29
WS-UB SWGR1	6570874	6120934	29
WS-UKL AL0.5	6570850	6120930	29
WS-UKL AL1	6570928	6120942	29
WS-UKL RW0.5	6570836	6120926	29
WS-UKL RW1	6570898	6120938	29
WS-UKL SWGR0.5	6570843	6120928	29
WS-UKL SWGR1	6570911	6120940	29

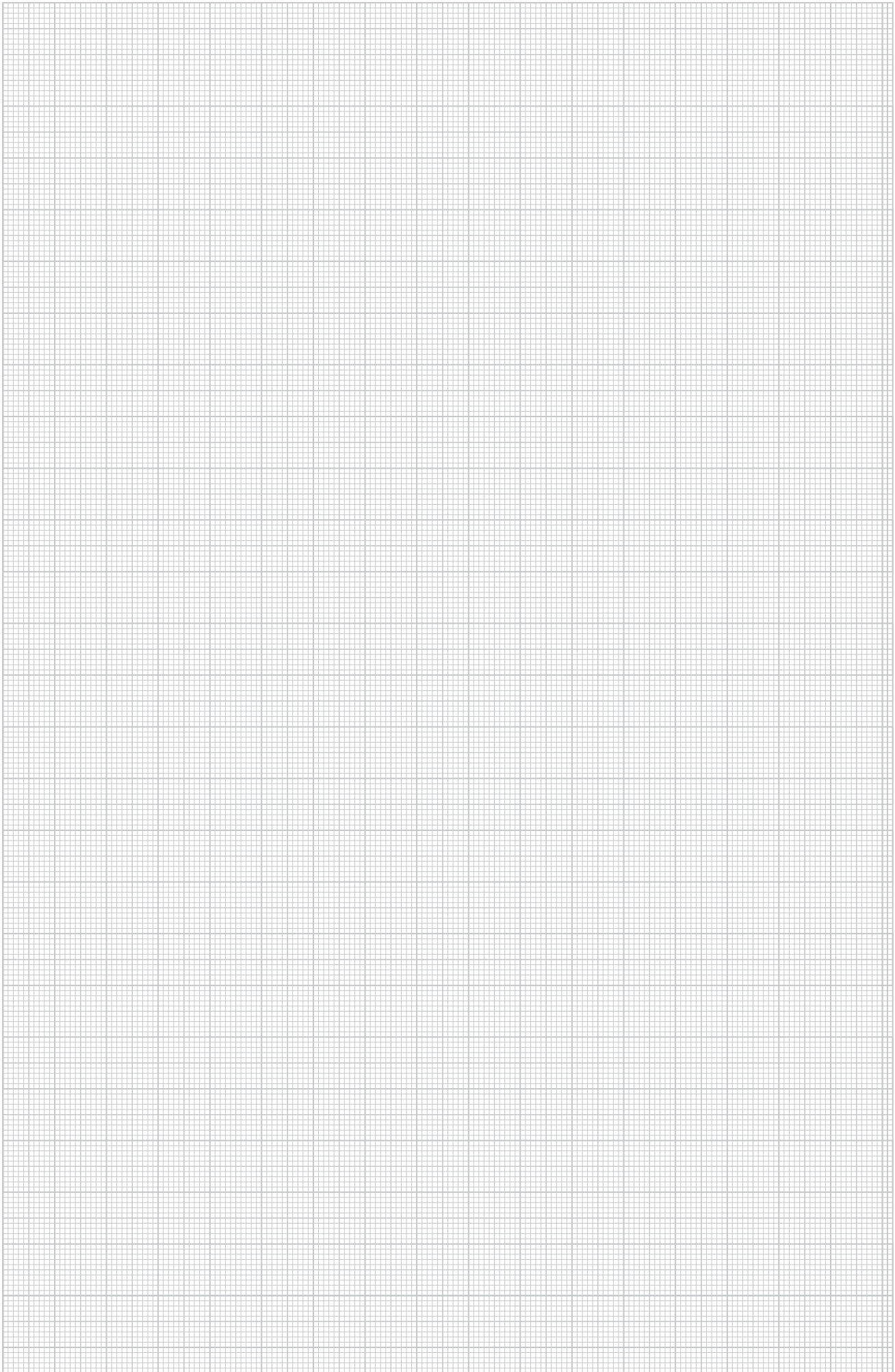

OBO Bettermann Ukraine, LLC
Kyiv 04080
Novokostyantynivska St. 9
Ukraine

Customer Service
Tel.: +38(044)4843089
info@obo.com.ua

www.obo.ua

Building Connections

